User Manual

1Ch Video Server

WARNINGS

TO REDUCE THE RISK OF FIRE OR ELECTRIC SHOCK, DO NOT EXPOSE THIS PRODUCT TO RAIN OR MISTURE.

DO NOT INSERT ANY METALLIC OBJECT THROUGH VENTILATION GRILLS.

CAUTION

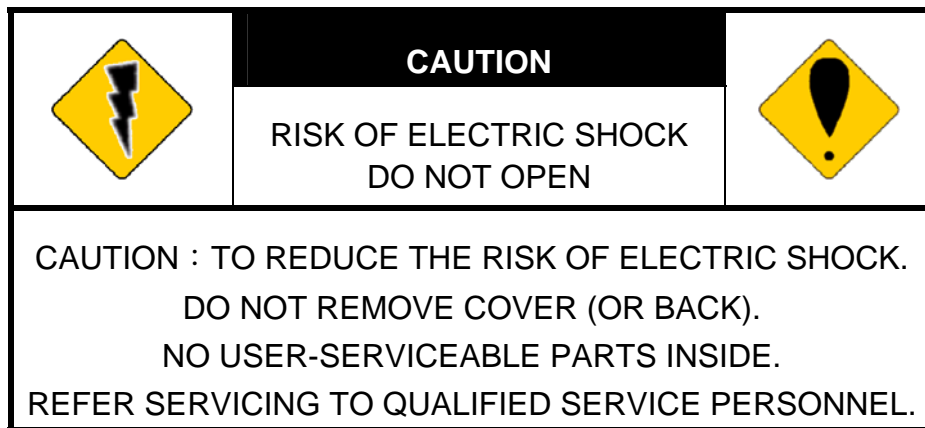

COPYRIGHT

THE TRADEMARKS MENTIONED IN THE MANUAL ARE LEGALLY REGISTERED TO THEIR RESPECTIVE COMPANIES.

Content

I.	PREFACE.....	4
II.	PRODUCT SPECIFICATIONS	4
III.	PRODUCT INSTALLATION.....	6
	A. MONITOR SETTING.....	6
	B. HARDWARE INSTALLATION	7
	C. IP ASSIGNMENT	9
	D. INSTALL ACTIVE X CONTROL:.....	12
IV.	LIVE VIDEO.....	14
V.	VIDEO SERVER CONFIGURATION.....	16
	A. SYSTEM	17
	B. NETWORK	20
	C. A/V SETTING	26
	D. EVENT LIST.....	32
VI.	NETWORK CONFIGURATION.....	36
VII.	FACTORY DEFAULT	38
VIII.	PACKAGE CONTENTS	38
	APPENDIX I.....	38

V1.8 2008/01/07

I. Preface

Video Server is a 1 channel video server with the web server built in. User views real-time video via IE browser. Video Server supports MPEG-4 and JPEG video compression which provides smooth and high video quality. The video can be stored in the SD card, and playback remotely.

With user friendly interface, it is an easy-to-use video server which can connect any kind of analogue camera to fit the customer's need.

II. Product Specifications

- MPEG4/ JPEG compression
- Supports SD card for local recording
- Wireless network connection [Optional]
- Support RS-232 / RS-485
- Support Cell Phone/PDA/3GPP
- Support Dual Streaming
- 2-way audio
- Support PTZ control
- Online firmware upgrade
- Compatible with Microsoft Windows Media Player

Specifications

Hardware	
CPU	ARM 9 ,32 bit RISC
SDRAM	64MB
Flash	8MB
Video in/ out	1 in/ 1 out, BNC connector
Audio in/ out	1 in/ 1 out, RCA Type
I/O	2 in/ 2 Relay out
RS-485	1, for PTZ control
RS-232	1
Power Consumption	LAN: 12V, 250mA / WLAN: 12V, 350mA
Dimensions (WxHxD)	134 x 42 x 107 mm
Weight	400 g

Network		
Ethernet	10/ 100 Base-T	
Wireless (Optional)	802.11b/g	
WEP	64/ 128 bit	
Network Protocol	HTTP, TCP/ IP, SMTP, FTP, PPPoE, DHCP, DDNS, NTP, UPnP, 3GPP	
System		
Video Resolution	NTSC : 720x480, 704x480, 352x240, 176x120 PAL : 720x576, 704x576, 352x288, 176x144	
Image snapshot	Yes	
Dual Streaming	Yes	
Full screen monitoring	Yes	
Compression format	MPEG-4/ JPEG	
Video bitrate adjust	CBR, VBR	
Motion Detection	Yes, 3 different areas	
Triggered action	Mail, FTP, Save to SD card	
Pre/ Post alarm	Yes, configurable	
Remote PTZ control	Yes	
Security	Password protection	
Firmware upgrade	HTTP mode, can be upgraded remotely	
Simultaneous connection	Up to 10	
Audio	Yes, 2-way	
SD card management		
Recording trigger	Motion Detection, IP check, Network Status (Wire connection only)	
Video format	AVI, JPEG	
Video playback	Yes	
File Management	Yes, can be deleted or overwrite	
Web browsing requirement		
OS	Windows 2000, XP, 2003, IE 6 or above	
Hardware	Suggested	Intel-C 2.0G, RAM : 512MB, Graphic card : 64MB
	Minimum	Intel-C 1.6G, RAM : 256MB, Graphic card : 32MB

III. Product Installation

A. Monitor Setting

- i. Right-Click on the desktop. Select “ Properties”



- ii. Change color quality to highest (32bit).

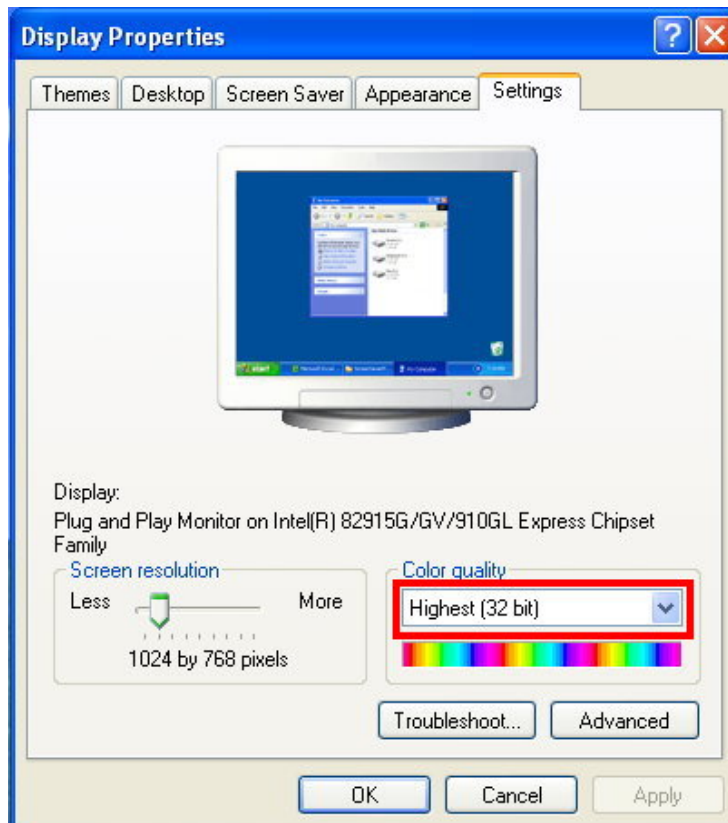

B. Hardware Installation

B-1: Hardware Connection

- i. Connect power adaptor



- ii. Connect Video Server to PC or network with Ethernet cable



- iii. Set up the network configurations according to the network environment. For further explanation, please refer to chapter VI, "Network Configuration for Video Server".

B-2: I/O Control Instruction

I/O terminal connector – used in application, for e.g., motion detection, event triggering, alarm notifications. It provides the interface to:

Digital Input (GND+Alarm) – An alarm input for connecting devices that can toggle between an open and closed circuit, for example: PIRs, door/window contacts, glass break detectors, etc. When a signal is received the state changes and the input becomes active.

Relay output (COM +N.O.) – An output to Relay switch, for example: LEDs, Sirens, etc

Digital Input

Alarm Input

1. GND (Ground) : Initial state is LOW
2. Alarm : Max. 50mA, 12VDC

Relay Output

1. COM: (Common)
2. N.O. (Normally Open): Max. 1A, 24VDC or 0.5A, 125VAC

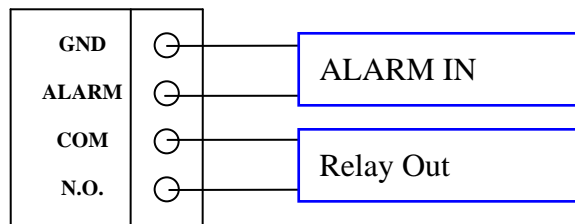

B-2 Relay Connection: Digital Input connection

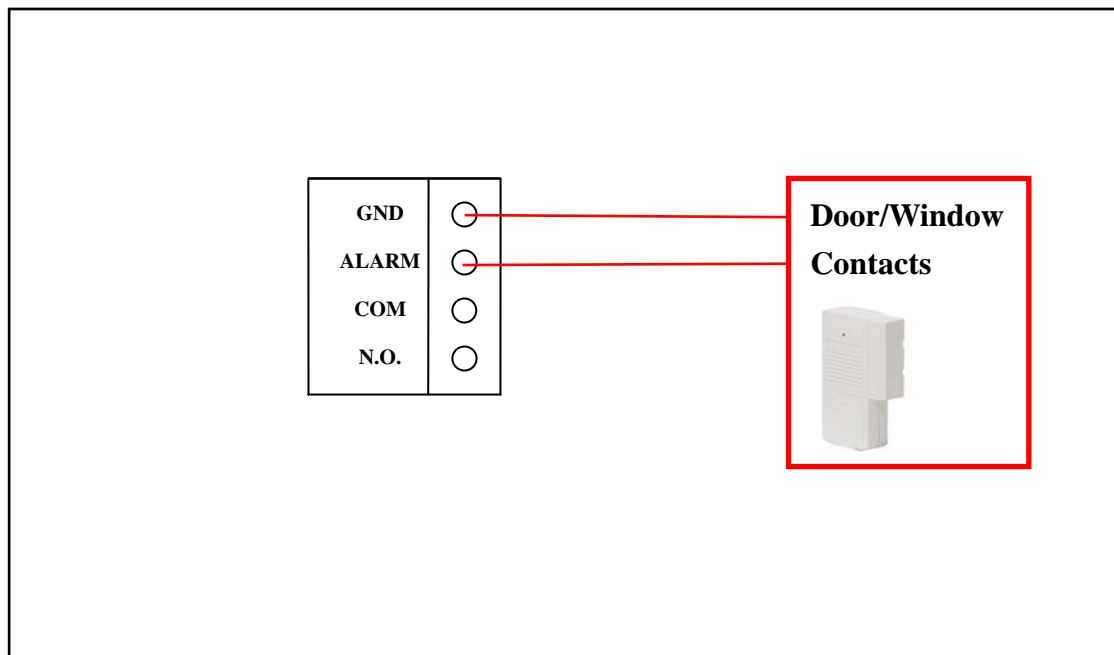

Relay Output Connection

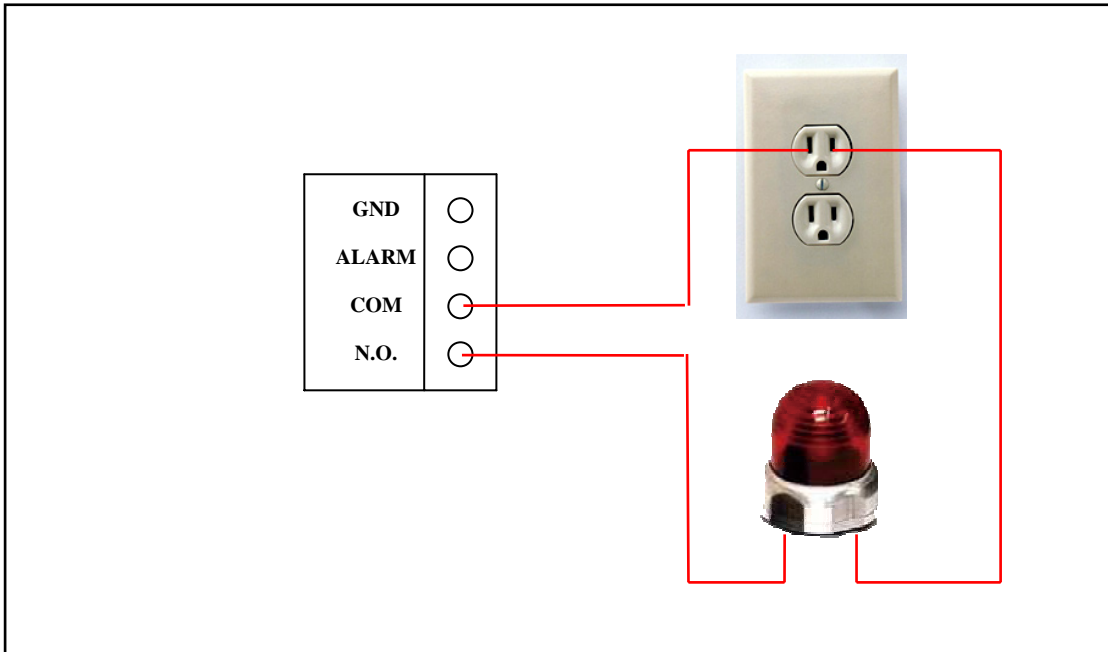

C. IP Assignment

- i. Use the software, "IP Installer" to assign the IP address of Video Server. The software is in the attached software CD.
- ii. There are two languages for the IP installer
 - a. IPInstallerCht.exe : Chinese version
 - b. IPInstallerEng.exe : English version
- iii. There are 3 kinds of IP configuration.
 - a. Fixed IP (Public IP or Virtual IP)
 - b. DHCP (Dynamic IP)
 - c. Dial-up (PPPoE)
- iv. Execute IP Installer
- v. For Windows XP SP2 user, it may popup the following message box. Please click "Unblock".



vi. IP Installer configuration :

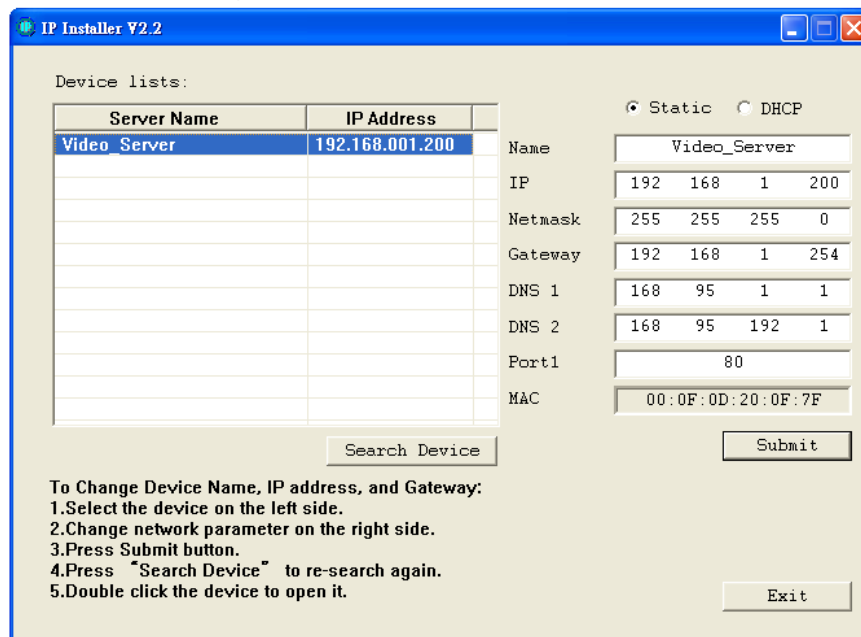

- vii. IP Installer will search all IP Devices connected on Lan. The user can click “Search Device” to search again.
- viii. Click the Video Server listed on the left side. The network configuration of this Video Server will show on the right side. You may change the “name” of the Video Server to your preference (eg: Office, warehouse). Change the parameter and click “Submit” then click “OK”. It will apply the change and reboot the Device.

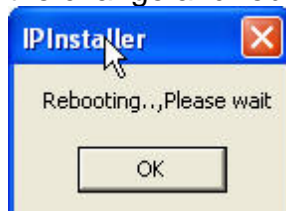

ix. Please make sure the subnet of PC IP address and Video Server IP address are the same.

The same Subnet:

Video Server IP address: 192.168.1.210

PC IP address: 192.168.1.110

Different Subnets:

Video Server IP address: 192.168.2.210

PC IP address: 192.168.1.110

To Change PC IP address:

Control Panel → Network Connections → Local Area Connection Properties → Internet Protocol (TCP/IP) → Properties

Please make sure your Video Server and PC have the same Subnet. If not, please change Video Server subnet or PC IP subnet accordingly.

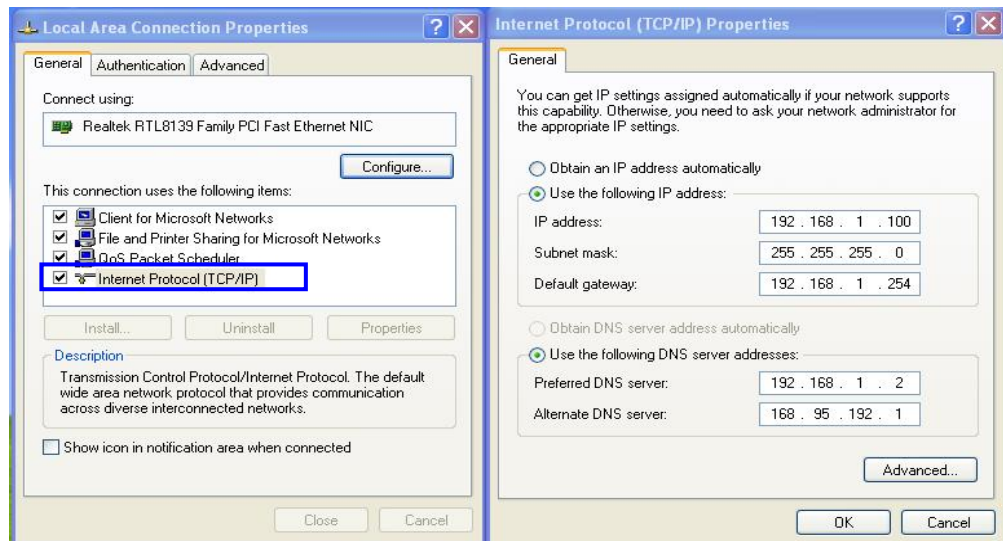

- x. A quick way to access remote monitoring is to left-click the mouse twice on a selected Video Server listed on "Device list" of IP Installer. An IE browser will be opened.

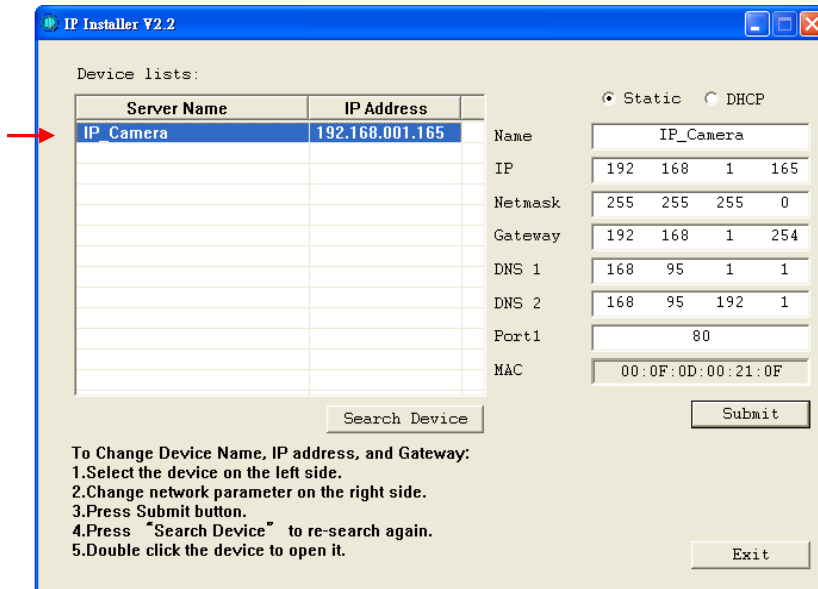

-
- xi. Then, please key in the default “user name: admin” and “password: admin”.

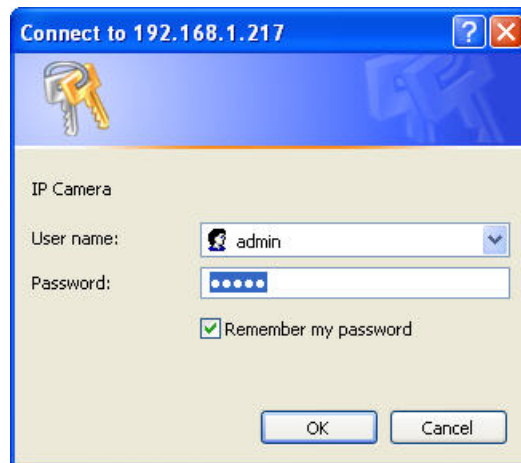

D. Install ActiveX control:

For the first time to view the video via IE, it will ask you to install the ActiveX component.

 This website wants to install the following add-on: 'WEBWATCH2.cab' from

If the installation failed, please check the security setting for the IE browser.

- i. IE → Tools → Internet Options... → Security Tab → Custom Level... → Security Settings → Download unsigned ActiveX controls → Select “Enable” or Prompt.
- ii. IE → Tools → Internet Options... → Security Tab → Custom Level... → Initialize and script ActiveX controls not marked as safe → Select “Enable” or Prompt.

1

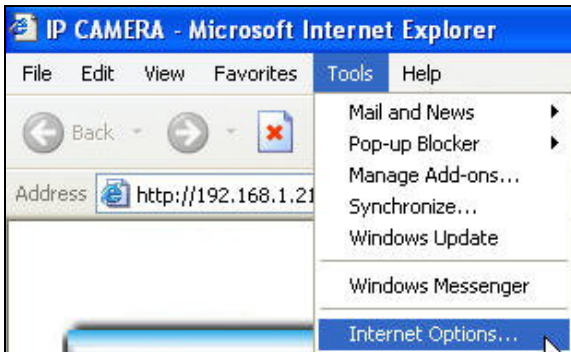

2

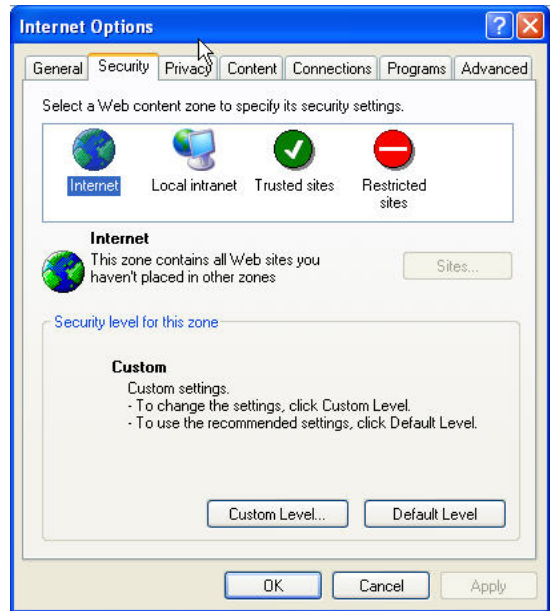

3

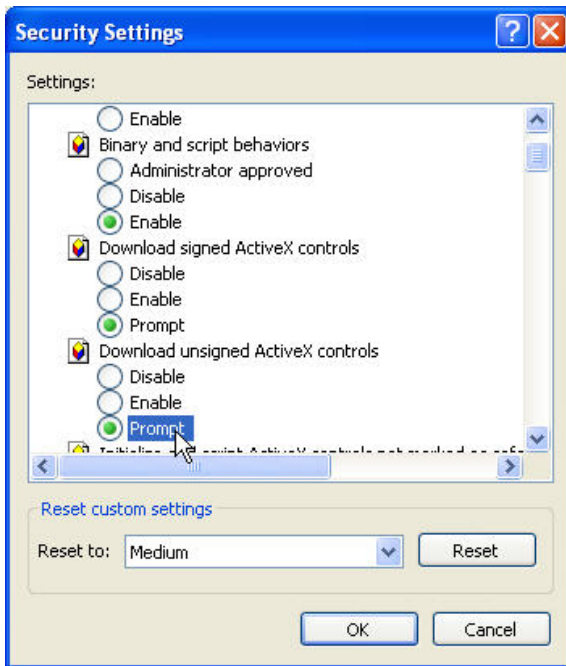

4

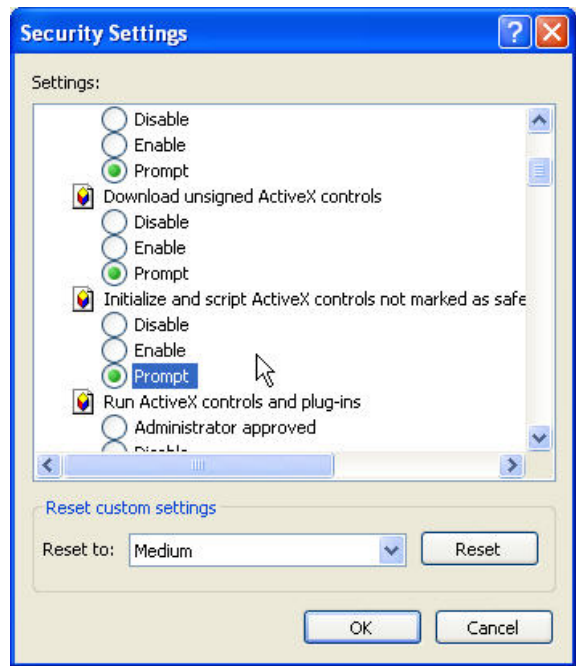

5

When popup the following dialogue box, click "Yes".

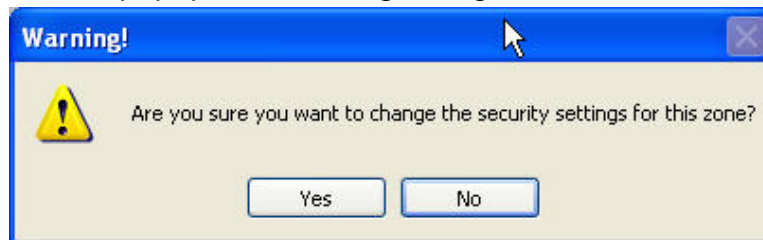

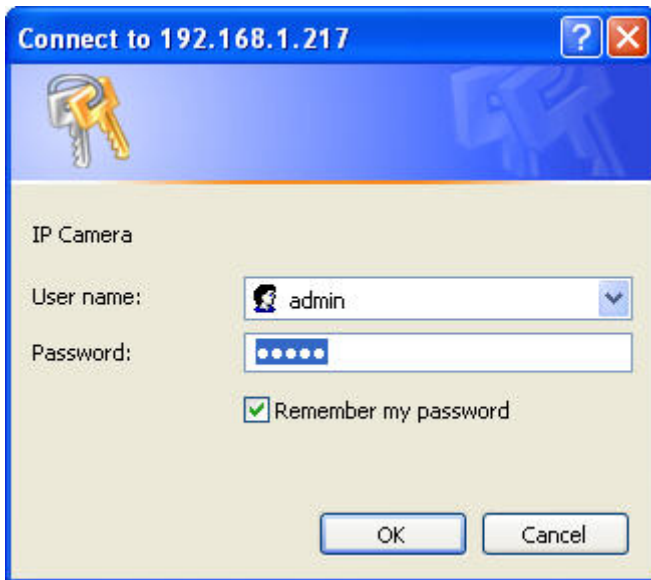

IV. Live Video

Start a IE browser, type the IP address of the Video Server in the address field. It will show the following dialogue box. Key-in the user name and password. The default user name and password are “**admin**” and “**admin**”.

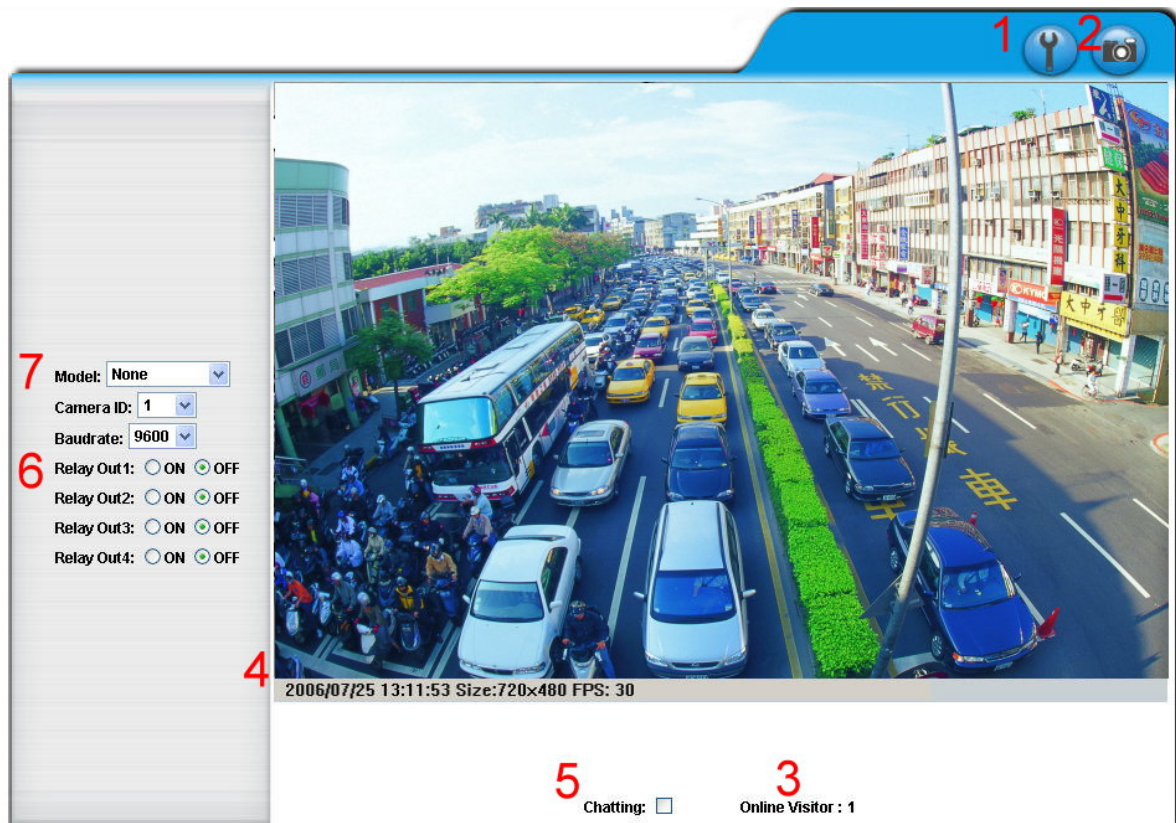

When connect to the Video Server ◦ The following program interface shows.



-
1.  : Get into the administration page

2.  : Video Snapshot

3. Shows how many people connect to this Video Server
4. Show system time, video resolution, and video refreshing rate
5. Video Server supports 2-way audio. Click the “Chatting” check box. Then you can use microphone which connect to the PC to talk to server side, which is Video Server side.
6. Control the relay which is connected to this video server.
7. Select PTZ protocol to control the PTZ camera which is connected to this video server. The PTZ function will be slightly different depends on which protocol to use.

Double-click the video, it will change to full screen mode. Press “Esc” or double-click the video again, it will change back to normal mode.

Right-Click the mouse on the video, it will show a pop-up menu.



1. Snapshot : Save a JPEG picture
2. Record Start : Record the video in the local PC. It will ask you where to save the video. To stop recording, right-click the mouse again. Select “Record Stop”. The video format is AVI. Use Microsoft Media Player to play the recorded file.
3. Mute : Turn of the audio. Click again to turn on it.
4. Full Screen : Full-screen mode.

V. Video Server Configuration



Click  to get into the administration page. Click



 to back to the live video page.



The screenshot displays the configuration page for a video server. On the left is a dark sidebar menu with icons and labels for various settings: System (gears), Network (globe), A/V Setting (film strip and speaker), and Event List (document). The main content area is titled 'System Information' and contains several sections: 'Server Information' with fields for Server Name (Video_Server), MAC Address (00:0F:0D:20:0C:B3), and Language (English selected); 'Overlay Setting' with radio buttons for Enabled (selected) and Disabled, and a Position dropdown (Top-Left selected); 'Time Setting' with fields for Server Time (2007/5/8 9:34:26), Date Format (yy/mm/dd selected), Time zone (GMT+08:00), and NTP options (NTP Server: 198.123.30.132, Synchronize with PC's time with Date: 2007/5/8 and Time: 9:35:49, Manual with Date: 2007/5/8 and Time: 9:26:4, and The date and time remain the same selected). An 'Apply' button is located at the bottom right of the configuration area.

A. System

i. System Information

a. Server Information : Set up the camera name, select language, and set up the camera time.

1. Server Name : This is the Video Server name. This name will show on the IP Installer.
2. Select Language : There are English, Traditional Chinese, and Simple Chinese to select. When change, it will show the following dialogue box for the confirmation of changing language.



b. Overlay Setting: select a position where date & time showing on screen.

Overlay Setting	
<input checked="" type="radio"/> Enabled	<input type="radio"/> Disabled
Position:	<input checked="" type="radio"/> Top-Left <input type="radio"/> Top-Right <input type="radio"/> Bottom-Left <input type="radio"/> Bottom-Right

c. Server time setting : Select options to set up time - "NTP", "Synchronize with PC's time", "Manual", "The date and time remain the same".

Time Setting	
Server Time:	2007/4/11 14:56:01 Time Zone: GMT+08:00
Date Format:	<input checked="" type="radio"/> yy/mm/dd <input type="radio"/> mm/dd/yy <input type="radio"/> dd/mm/yy
Time zone:	GMT+08:00
<input checked="" type="radio"/> NTP :	GMT-09:00
NTP Server :	GMT-08:00
<input type="radio"/> Synchronize	GMT-07:00
Date :	GMT-06:00
Time :	GMT-05:00
<input type="radio"/> Manual	GMT-04:00
Date :	GMT-03:30
Time :	GMT-03:00
<input type="radio"/> The date and	GMT-02:00
time remain the same	GMT-01:00
	GMT-00:00
	GMT+01:00
	GMT+02:00
	GMT+03:00
	GMT+03:30
	GMT+04:00
	GMT+04:30
	GMT+05:00

ii - User Management

Video Server supports three different users, administrator, general user, and anonymous user.

The screenshot shows a web interface titled "User Management". It has three main sections: "Anonymous User Login", "Add User", and "User List".

- Anonymous User Login:** Contains two radio buttons, "YES" and "NO". The "NO" button is selected. There is a "Setting" button to the right.
- Add User:** Contains three input fields labeled "Username:", "Password:", and "Confirm:". There is an "Add/Set" button to the right.
- User List:** A table with the following content:

Username	User Group	Modify	Remove
admin	Administrator	Edit	

- Anonymous User Login :
Yes : Allow anonymous login
No : Need user name & password to access this Video Server
- Add user :
Type the user name and password, then click "Add/Set".
Note: Allow guest to login as a Guest. Guest is only allowed to browse the page.
- Click "edit" or "delete" to modify the user.

The screenshot shows a dialog box titled "User Setup" within a "Microsoft Internet Explorer" window. The dialog box has three input fields: "Username:" with the value "admin", "Password:", and "Confirm:". There is an "OK" button to the right of the "Confirm:" field.

iii 、 System update :

The screenshot shows a web interface titled "System Update" with the following sections:

- Firmware Upgrade**: Shows "Firmware Version: V3.2.20" and a "New Firmware:" field with a "浏览..." (Browse...) button and an "Upgrade" button.
- Reboot System**: A section with a "Start" button.
- Factory Default**: A section with a "Start" button.
- Setting Management**: Contains instructions: "Right click the mouse button on **Setting Download** and then select **Save As** to save current system's setting in the PC." It includes a "Save As a File:" label, a "New Setting File:" field with a "浏览..." (Browse...) button, and an "Upgrade" button.

- a. To update the firmware online, click "Browse..." to select the firmware. Then click "Upgrade" to proceed.
- b. Reboot system : re-start the IP camera
- c. Factory default : delete all settings and restore defaults system.
- d. Setting Management : User may download the current setting to PC, or upgrade from previous saved setting.
 1. Setting download:
Right-click the mouse button on Setting Download → Select "Save AS..." to save current IP CAM setting in PC → Select saving directory → Save
 2. Upgrade from previous setting
Browse → search previous setting → open → upgrade → Setting update confirm → click **index.html**. to return to main page

B.Network

i. IP Setting

Video Server supports DHCP and static IP.

IP Setting	
IP Assignment	
<input type="radio"/> DHCP	
<input checked="" type="radio"/> Static	
IP Address:	<input type="text" value="192.168.1.200"/>
Subnet Mask:	<input type="text" value="255.255.255.0"/>
Gateway:	<input type="text" value="192.168.1.254"/>
DNS 0:	<input type="text" value="168.95.1.1"/>
DNS 1:	<input type="text" value="168.95.192.1"/>
Port Assignment	
Web Page Port:	<input type="text" value="80"/>
RTSP Port :	<input type="text" value="554"/>
RTP Start Port:	<input type="text" value="5000"/> [1024..10000]
RTP End port:	<input type="text" value="9000"/> [1025..10000]
UPnP	
UPnP:	<input checked="" type="radio"/> Enabled <input type="radio"/> Disabled
<input type="button" value="Apply"/>	

- a. DHCP : Using DHCP, IP Vandal Dome will get all the network parameters automatically.
- b. Static IP : Please type in IP address, subnet mask, gateway, and DNS manually.
- c. Port Assignment: user may need to assign different port to avoid conflict when setting up IP assignment.
 1. Web Page Port: setup web page connecting port and video transmitting port (Default: 80)
 2. RTSP Port: setup port for RTSP transmitting (Default: 554)
 3. RTP Start and End Port: in RTSP mode, you may use TCP and UDP for connecting. TCP connection uses RTSP Port (554). UDP connection uses RTP Start and End Port.

d. UPnP

This IP camera supports UPnP, If this service is enabled on your computer, the camera will automatically be detected and a new icon will be added to “My Network Places.”

Note: UPnP must be enabled on your computer.

Please follow the procedure to activate UPnP

1. open the Control Panel from the Start Menu
2. select Add/Remove Programs
3. Select Add/Remove Windows Components and open Networking Services section
4. Click Details and select UPnP to setup the service
5. The IP device icon will be added to “MY Network Places”
6. User may double click the IP device icon to access IE browser

ii、 PPPoE：

PPPoE

PPPoE Setting

Enabled Disabled

Username:

Password:

Send mail after dialed

Enabled

Subject:

Select “Enabled” to use PPPoE.

Key-in Username and password for the ADSL connection.

Send mail after dialed：When connect to the internet, it will send a mail to a specific mail account. For the mail setting, please refer to “Mail and FTP” settings.

iii、 DDNS：

Video Server supports DDNS (Dynamic DNS) service.

a. DynDNS：

DDNS

DDNS Setting

Enabled Disabled

Provider:

Hostname:

Username:

Password:

Schedule Update: Minutes

State

Note:

1. Schedule Update: Feature of DDNS schedule update is designed for IP products which installed behind the ICS or NAT devices. Update range from every 5 (minutes) to 5000 (minutes) and 0 remain to off.

2. Please note that the hostname will be blocked by DynDNS.org if schedule update is more than once every 5 minutes to 60 minutes. In general, schedule update in every 1440 minutes is recommended.

1. Enable this service

2. Key-in the DynDNS server name, user name, and password.

3. Set up the IP refreshing rate.
4. Click “Apply”
5. If setting up IP schedule update too frequently, the IP may be blocked. In general, schedule update every day (1440 minutes) is recommended.

b. Camddns service :

DDNS

DDNS Setting

Enabled Disabled

Provider: ddns.camddns.com

Username:

Schedule Update: 1440 **Minutes**

State

Idle

Apply

Note:

1. **Schedule Update:** Feature of DDNS schedule update is designed for IP products which installed behind the ICS or NAT devices. Update range from every 5 (minutes) to 5000 (minutes) and 0 remain to off.
2. Please note that the hostname will be blocked by DynDNS.org if schedule update is more than once every 5 minutes to 60 minutes. In general, schedule update in every 1440 minutes is recommended.

1. Please enable this service
2. Key-in user name
3. IP Schedule update is default at 5 minutes
4. Click “Apply”.

c. DDNS Status

1. Updating : Information update
2. Idle : Stop service
3. DDNS registration successful, can now log by
http://<username>.ddns.camddns.com : Register successfully.
4. Update Failed, the name is already registered : The user name has already been used. Please change it.
5. Update Failed, please check your internet connection : Network connection failed.
6. Update Failed, please check the account information you provide : The server, user name, and password may be wrong.

iv 、 Wireless Setting (Wireless Network Optional)

Supports 802.11 b/g wireless connection.

Notice : Wireless network and Ethernet network use the same IP, the user has to unplug Ethernet cable, if Ethernet cable is not unplug, wireless setting can not be executed.

SSID	Mode	Security	Signal strength
allan	Infrastructure	WPA	79
RHOSON	Infrastructure	WEP	16
Link	Infrastructure	OFF	16
SinoStar	Infrastructure	WEP	11
7f-2	Infrastructure	WEP	12
00160159A7FA	Infrastructure	WEP	56
RDTEST	Infrastructure	WEP	48
3Com	Infrastructure	OFF	43
Default	Infrastructure	WPA	74

MAC Address:	00:16:16:16:DD:E1
Mode:	Infrastructure
Operation Mode:	Auto
SSID:	allan
Security:	None

Apply

a. Status of Wireless Networks :

scan all wireless services.

b. Wireless Setting :

1. **Mode** : There are Infrastructure and Ad-hoc. Infrastructure is for connecting with the router. Ad-hoc is for connecting with PC. There is “Channel” to select only when user uses Ad-hoc mode.

e.g. If one PC’s channel is 1, the other’s channel has to 1, too.

MAC Address:	00:11:E2:03:37:48
Mode:	Ad-hoc
Operation Mode:	Auto
SSID:	Default
Channel:	6
Security:	None

2. **SSID** : Based on AP setting.
3. **Channel** : This is only be used when the user selects Ad-hoc mode in order to avoid conflict.
4. **Security** : It supports “None”, “WEP”, “WPA-PSK” security encryption based on the setting of the Router.

5. WEP :

Security:	WEP
WEP Setting	
Authentication:	Open System
Encryption:	64 bit
Key Type:	HEX (10 character max)
Key 1:	<input checked="" type="radio"/> <input type="text"/>
Key 2:	<input type="radio"/> <input type="text"/>
Key 3:	<input type="radio"/> <input type="text"/>
Key 4:	<input type="radio"/> <input type="text"/>

- Authentication : There are Open System and Shared Keys, it is based on different encryptions. This has to be the same as the Router's setting.
- Encryption : There are 64 bits and 128 bits. This is based on Key Type based on the Router's setting.
- Key Type : There are HEX and ASCII. When selecting HEX, the user only can input 0~9 characters and use A, B, C, D, E, and F.
- When selecting ASCII, the user can input any character.
(Case sensitive)
- Key 1~4 : Based on Key Type to input characters.

6. WPA-PSK

Security:	WPA-PSK
WPA-PSK Setting	
Encryption	TKIP
Pre-Shared Key:	<input type="text"/> (ASCII format, 8-63)

- Encryption : There are TKIP and AES.
- Pre-Shared Key : Allow any characters. (Case sensitive)

C.A/V Setting

i、 Image Setting

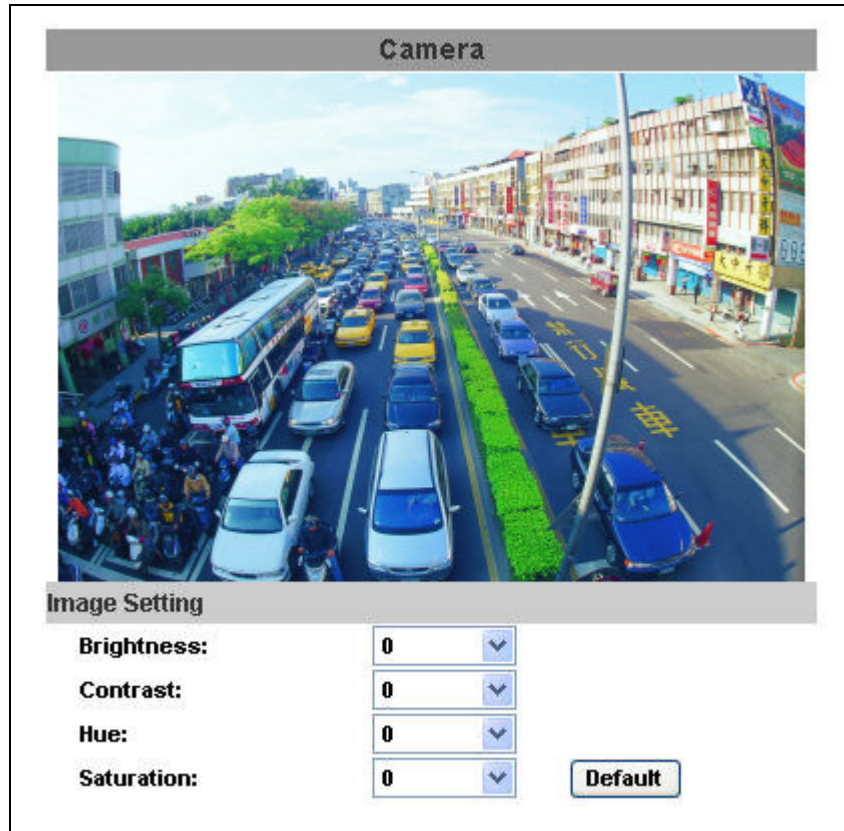

Adjust “Brightness”, “Contrast”, “Hue”, “Saturation” to get clear video.

ii、 Video Setting

User may select 2 streaming output simultaneously:

Streaming 1 Setting: Basic mode and Advanced mode

Streaming 2 Setting: Basic mode, Advanced mode, and 3GPP mode

(Max Video Frame Rate for both streaming combined is 30 FPS)

a. Streaming 1 Basic Mode :

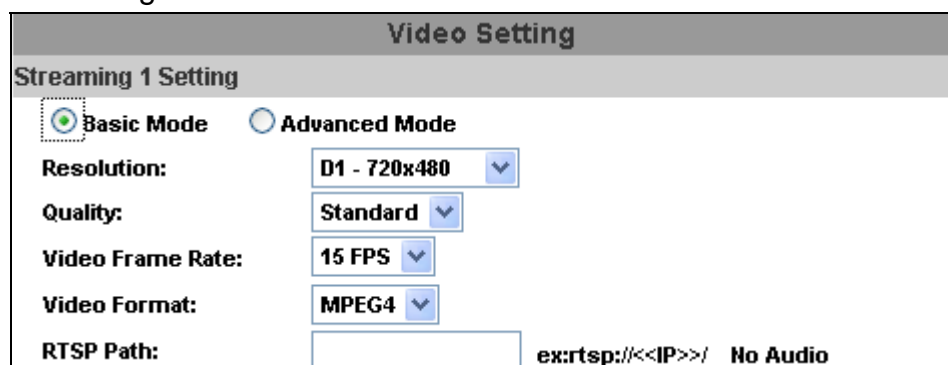

1. Resolution :

There are 4 resolutions to choose.

		NTSC	/	PAL
D1	–	720×480	/	720×576
4CIF	–	704×480	/	704×576
CIF	–	352×240	/	352×288
QCIF	–	176×120	/	176×144

2. Quality :

There are 5 levels to adjust:

Best/ High/ Standard/ Medium/ Low

The higher the quality is, the bigger the file size is.

Also not good for internet transmitting

3. Video Frame Rate : The video refreshing rate per second.

4. Video Format : MPEG4 or JPEG.

5. RTSP Path: RTSP output name

b. Streaming 1 Advanced Mode :

The screenshot shows a 'Video Setting' dialog box with a 'Streaming 1 Setting' sub-dialog. The 'Advanced Mode' radio button is selected. The settings are as follows:

- Resolution:** D1 - 720x480
- Bitrate Control Mode:** VBR (selected), CBR
- Video Quantitative:** 9
- Video Bitrate:** 1.5Mbps
- Video Frame Rate:** 30 FPS
- GOP Size:** 1 X FPS, with a note 'GOP = 30'
- Video Format:** MPEG4
- Video Orientation:** Flip and Mirror (both unchecked)
- RTSP Path:** A text input field containing 'ex:rtsp://<<IP>>/' followed by 'No Audio'.

1. Resolution :

There are 4 resolutions to choose.

		NTSC	/	PAL
D1	–	720×480	/	720×576
4CIF	–	704×480	/	704×576
CIF	–	352×240	/	352×288
QCIF	–	176×120	/	176×144

2. Bitrate Control Mode

There are CBR [Constant Bit Rate] and VBR [Variable Bit

Rate) to use.

CBR : 32Kbps~4Mbps – Increase CBR to increase the picture quality; vise versa

VBR : 1(Low)~10(High) – Compression rate, the higher the compression rate, the lower the picture quality is; vise versa. The balance between VBR and network bandwidth will affect picture quality. Please carefully select the VBR rate to avoid picture breaking up or lagging.

3. Video Frame Rate

Picture display frame per second

NTSC: Max 30 frames/second PAL: Max 25 frames/second

4. GOP Size

It means "Group of Pictures". The higher the GOP is, the better the quality is.

5. Video Format :

There are 2 Video Format to choose
MPEG4 or JPEG.

6. RTSP Path: RTSP output connecting route

c. Streaming 2 Basic Mode :

Streaming 2 Setting

Basic Mode Advanced Mode 3GPP Mode Close

Resolution: QCIF - 176x120

Quality: Low

Video Frame Rate: 5 FPS

Video Format: MPEG4

RTSP Path: v2 ex:rtsp://<<IP>>/v2 No Audio

1. Resolution :

There are 4 resolutions to choose.

	NTSC	/	PAL
D1	– 720x480	/	720x576
4CIF	– 704x480	/	704x576
CIF	– 352x240	/	352x288
QCIF	– 176x120	/	176x144

2. Quality :

There are 5 levels to adjust:

Best/ High/ Standard/ Medium/ Low

The higher the quality is, the bigger the file size is. Also not

- good for internet transmitting
- 3. Video Format : MPEG4 or JPEG
- 4. RTSP Path: RTSP output connecting route

d. Streaming 2 Advanced Mode :

The screenshot shows the 'Streaming 2 Setting' dialog box with the 'Advanced Mode' radio button selected. The settings are as follows:

- Resolution:** QCIF - 176x120
- Bitrate Control Mode:** CBR
- Video Quantitative:** 7
- Video Bitrate:** 128Kbps
- Video Frame Rate:** 5 FPS
- GOP Size:** 1 X FPS (with a note 'GOP = 5')
- Video Format:** MPEG4
- RTSP Path:** v2 (with a preview 'ex:rtsp://<<IP>>/v2 No Audio')

1. Resolution :

There are 4 resolutions to choose.

	NTSC	/	PAL
D1	720x480	/	720x576
4CIF	704x480	/	704x576
CIF	352x240	/	352x288
QCIF	176x120	/	176x144

2. Bitrate Control Mode

There are CBR [Constant Bit Rate] and VBR [Variable Bit Rate] to use.

CBR : 32Kbps~4Mbps (the higher the CBR is, the better the video quality is)

VBR : 1~10 (Compression Rate)

3. Video Frame Rate

The video refreshing rate per second.

4. GOP Size

It means "Group of Pictures". The higher the GOP is, the better the quality is.

5. Video Format : MPEG4 or JPEG

6. RTSP Path: RTSP output name

e. Streaming 2, 3GPP mode:

Streaming 2 Setting

Basic Mode
 Advanced Mode
 3GPP Mode
 Close

Resolution:

Bitrate Control Mode: CBR VBR

Video Quantitative:

Video Bitrate:

Video Frame Rate:

GOP Size: **GOP = 20**

Video Format:

3GPP Path: **ex:rtsp://<<IP>>/3g Audio:AMR**
ex:rtsp://<<IP>>/3gx No Audio

3GPP default value is QQVGA , 128Kbp , 5FPS , GOP=1XFPS

3GPP mode suggested setting: QQVGA, lower than 128kbps, 5FPS, GOP= 1x FPS or 2x FPS, MPEG4 format

3GPP can achieve up to 10FPS, In 3GPP mode, Stream 1 & Stream 2 combined frame rate is 20FPS

1. Fix Resolution :

QCIF – 176x120 / 176x144

2. Bitrate Control Mode

There are CBR [Constant Bit Rate] and VBR [Variable Bit Rate] to use.

CBR : 32Kbps~320bps (the higher the CBR is, the better the video quality is)

VBR : 1~10 (Compression Rate)

3. Video Frame Rate (**5 FPS is recommended**)

The video refreshing rate per second.

4. GOP Size

It means "Group of Pictures". The higher the GOP is, the better the quality is.

5. Video Format : MPEG4 or JPEG

6. 3GPP: 3GPP output name

iii 、 Audio :

Video Server supports 2-way audio.

- a. From video server to local PC, select "Enable" to start this function (When enabled, you can send audio via external mic in the IP Camera)



- b. From local PC to Video Server, check “chatting” in the browsing page (You will need a mic to send audio from local PC to IP Camera)

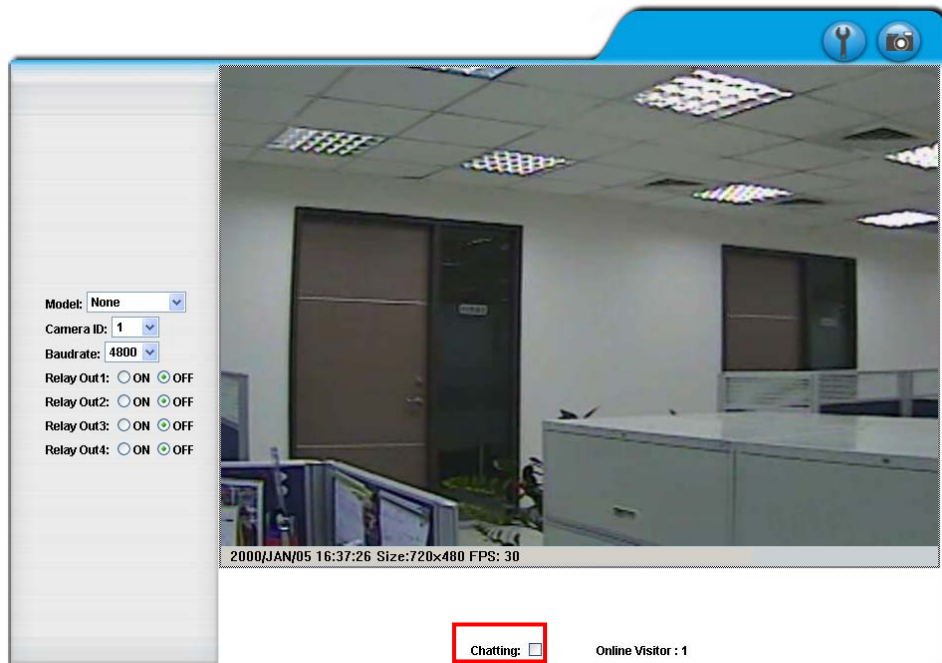

The Audio will not be smooth when enable SD card recording function simultaneously.

D.Event List

Video Server provides multiple event settings.

i、 Event Setting

The screenshot displays the 'Event Setting' configuration window. At the top, there is a 'Motion Detection' section with a video preview showing three detection areas: Area 1 (blue), Area 2 (green), and Area 3 (red). Below the preview, the 'Area Setting' section allows configuration for each area, including Sensitivity (set to 10(High)), notification options (E-mail, FTP, Out1, Out2), and a 'Save to SD card' checkbox. The 'Log' section includes checkboxes for E-mail and FTP, and a 'Subject' field set to 'IP Camera Warning!'. The 'Interval' is set to 10 sec. The 'Record File' section shows a dropdown menu for 'File Format' with options like 'JPEG Files...', 'AVI File...', and 'JPEG File(Single File...)'. The 'Network IP Check' section has radio buttons for 'Enabled' and 'Disabled' (selected), an 'IP Address' field with 'www.google.com', an 'Interval' set to 30 sec, and a 'Save to SD card' checkbox. An 'Apply' button is located at the bottom right.

a. Motion Detection :

Video Server allows 3 areas motion detection. When motion is triggered, it can send the video to some specific mail addresses, transmit the video to remote ftp server, trigger the relay, and save video to local SD card. To set up the motion area, click “Area Setting”. Using mouse to drag and draw the area. The same operation for area 2 and 3.

b. Record File Setting: IP CAMERA allows 3 different types of recording file to change its record size.

When motion/alarm is triggered, there are 3 different types of

record mode.

1. AVI File (With Record File Setting)
 2. Multi-JPEG (With Record File Setting), only with JPEG compression format.
 3. Single JPEG (Single File with Interval Setting)
- c. Record Time Setting :
- Pre Alarm and Post Alarm setups for video start and end time when motion detected, I/O, or other devices got triggered.
- Note: Pre/Post Alarm record time is base on record time setting and IP Cam built-in Ram memory. Limited by IP Cam built-in Ram Memory, When information is too much or video quality set too high, it will cause recording frame drop or decrease on post alarm recording time.
- d. Network Dis-connected
- When the network is down, it will save the video to local SD card.
This function is only enabled in wire connection.
- e. Network IP check
- When the connection is down, it records the video to SD card. Make sure the video recording is continuous. To use this function, key in the IP address of the PC which has recording software installed. Enable the function of “Save to SD card”, then click “Apply”.
The interval of two video files on SD card is fixed with 30 seconds.

ii - I/O Setting

Video Server supports 2 input/ 2 Relay output. When input is triggered, it can send the video to some specific mail addresses, transmit the video to remote ftp server, trigger the relay, and save video to local SD card.

I/O Setting

Input Setting

Input 1 Sensor: H.O

Input 1 Action: E-mail FTP Out1 Out2 Save to SD card

Input 2 Sensor: H.O

Input 2 Action: E-mail FTP Out1 Out2 Save to SD card

Subject: GPIO In Detected!

Interval: 10 sec

Output Setting

Mode Setting: OnOff Switch Time Switch

Interval: 10 sec

Apply

iii、Mail & FTP

To send out the video via mail of ftp, please set up the configuration first.

Mail & FTP	
Mail Setting	
Mail Server:	<input type="text"/>
Username:	<input type="text"/>
Password:	<input type="text"/>
Sender's Mail:	<input type="text"/>
Receiver's Mail:	<input type="text"/>
Bcc Mail:	<input type="text"/>
FTP Setting	
FTP Server:	<input type="text"/>
Username:	<input type="text"/>
Password:	<input type="text"/>
Port:	<input type="text" value="21"/>
Path:	<input type="text" value="/"/>
<input type="button" value="Apply"/>	

iv、Log List

Log List	
System Logs	Logs
Motion Detection Logs	Logs
I/O Logs	Logs
All Logs	Logs

Sort by System Logs, Motion Detection Logs and I/O Logs. In addition, System Logs and I/O Logs won't lose data due to power failure.

v、SD card

Please Insert SD card before use it. Make sure pushing SD card into the slot completely.

Note : The use of the SD card will affect the operation of the Video Server slightly, such as affecting the frame rate of the



a. Playback :

Playback	
19700101	20060417
SD Card: << 878M / 982M >>	

-
1. It will show the capacity of the SD card. Click the date listed on this page. It will show the list of the video.

2006/04/17			Del
Time	Video	Event Type	<input type="checkbox"/>
09:05:22	090522f.avi	Network Dis-connected	<input type="checkbox"/>
09:05:52	090552f.avi	Network Dis-connected	<input type="checkbox"/>
09:06:22	090622f.avi	Network Dis-connected	<input type="checkbox"/>
09:06:52	090652f.avi	Network Dis-connected	<input type="checkbox"/>
09:07:22	090722f.avi	Network Dis-connected	<input type="checkbox"/>
09:07:52	090752f.avi	Network Dis-connected	<input type="checkbox"/>
09:08:22	090822f.avi	Network Dis-connected	<input type="checkbox"/>
09:08:51	090851f.avi	Network Dis-connected	<input type="checkbox"/>
09:09:21	090921f.avi	Network Dis-connected	<input type="checkbox"/>
09:09:51	090951f.avi	Network Dis-connected	<input type="checkbox"/>

1 2 3 4 5

2. The video format is AVI. Click the video to start Microsoft Media Player to play it.
3. To delete the video, check it, then click **Del**. When the SD card is full, it will remove the oldest video automatically.

VI. Network Configuration

i、 Configuration 1 :

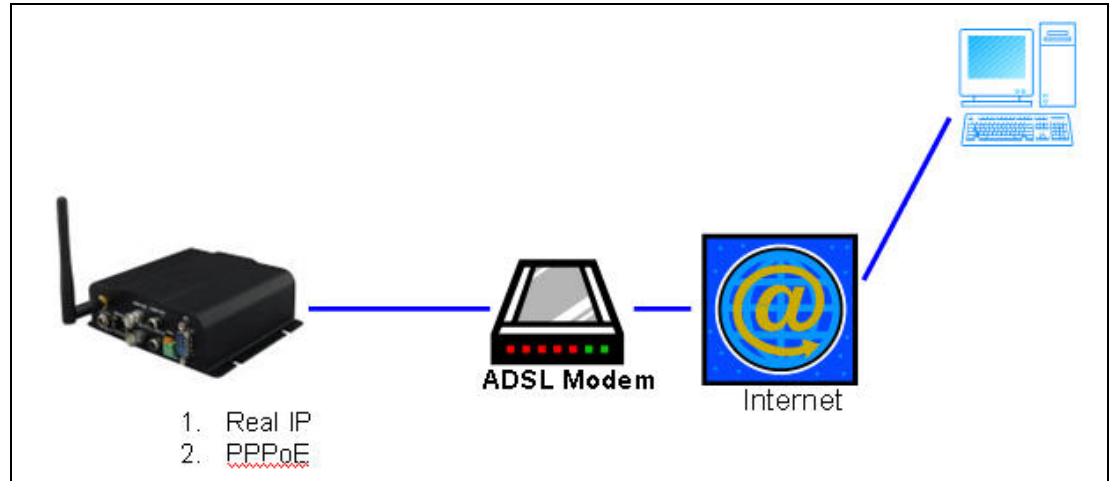

- A. Internet Access : ADSL or Cable Modem
- B. IP address : One real IP or one dynamic IP
- C. Only Video Server connects to the internet
- D. For fixed real IP, set up the IP into Video Server. For dynamic IP, start PPPoE.

ii、 Configuration 2 :

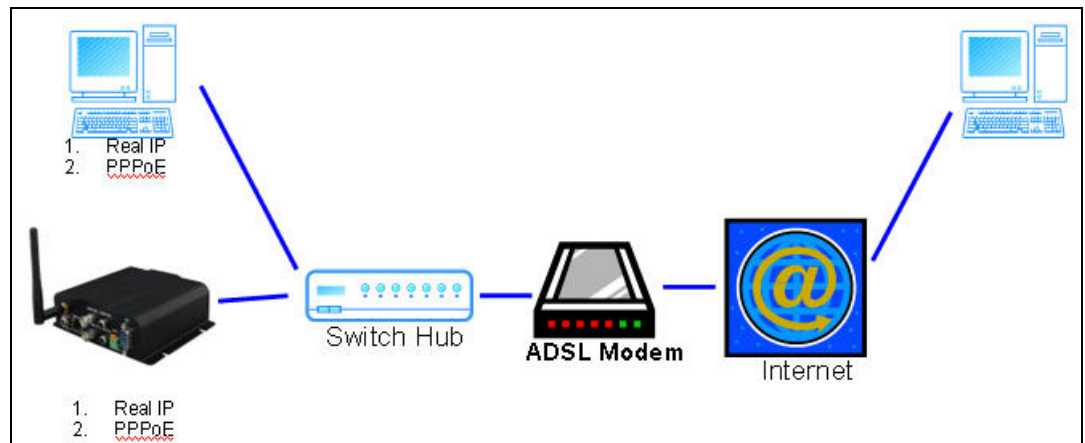

- a. Internet Access : ADSL or Cable Modem
- b. IP address : More than one real IP or one dynamic IP
- c. Video Server and PC connect to the internet
- d. Device needed : Switch Hub
- e. For fixed real IP, set up the IP into Video Server and PC. For dynamic IP, start PPPoE.

iii - Configuration 3 :

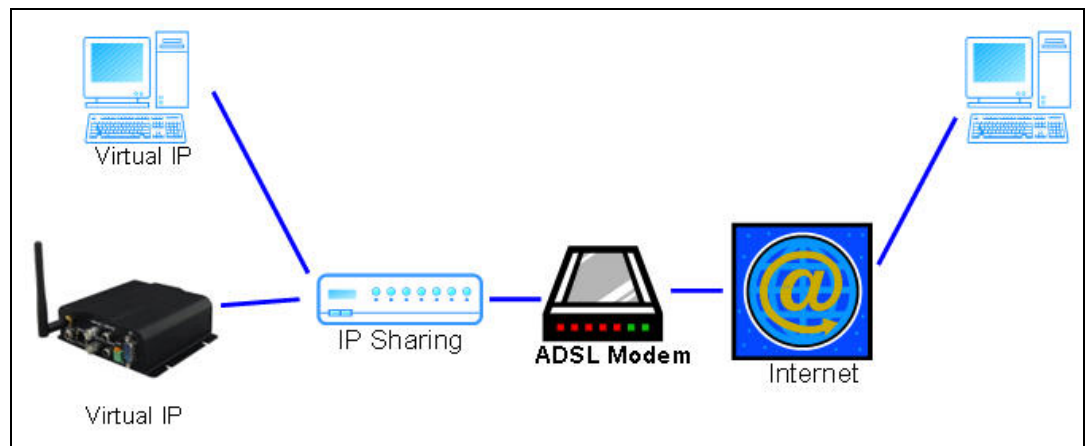

- a. Internet Access : ADSL or Cable Modem
- b. IP address : one real IP or one dynamic IP
- c. Video Server and PC connect to the internet
- d. Device needed : IP sharing
- e. Use virtual IP, set up port forwarding in IP sharing.

VII. Factory Default

- i 、 To recover the default IP address and password, please follow the following steps.
- ii 、 Remove power and press and hold the button in the back of Video Server.



- iii 、 Power on the Video Server. Don't release the button during the system booting.
- iv 、 It will take around 30 seconds to boot the Video Server.
- v 、 Release the button when Video Server finishes proceed.
- vi 、 Re-login the Video Server using the default IP (<http://192.168.1.210>), and user name (admin), password (admin).

VIII. Package contents

- i 、 Video Server
- ii 、 Adaptor
- iii 、 Ethernet Cable
- iv 、 CD title (User manual, IP installation Utility)

Appendix I

SD Card Recommended :

SanDisk 128M	Transcend 128M 80X
SanDisk 256M	Transcend 256M 80X
SanDisk 512M	Transcend 512M 80X
SanDisk 1G	Transcend 1G 80X
SanDisk 2G	Transcend 2G 80X
SanDisk 4G	Transcend 4G 80X