

User Manual

CMOS 1.3 Mega Pixel IP Vandal Dome Camera





WARNINGS

TO REDUCE THE RISK OF FIRE OR ELECTRIC SHOCK, DO NOT EXPOSE THIS PRODUCT TO RAIN OR MOISTURE.

DO NOT INSERT ANY METALLIC & ELETRIC CONDUCTIVE OBJECT THROUGH VENTILATION GRILLS.

CAUTION

	CAUTION RISK OF ELECTRIC SHOCK DO NOT OPEN	
CAUTION : TO REDUCE THE RISK OF ELECTRIC SHOCK. DO NOT REMOVE COVER (OR BACK). NO USER-SERVICEABLE PARTS INSIDE. REFER SERVICING TO QUALIFIED SERVICE PERSONNEL.		

COPYRIGHT

THE TRADEMARKS MENTIONED IN THE MANUAL ARE LEGALLY REGISTERED TO THEIR RESPECTIVE COMPANIES.

Content

I.	PREFACE.....	4
II.	PRODUCT SPECIFICATIONS	4
III.	PRODUCT INSTALLATION.....	6
	A. MONITOR SETTING.....	6
	B. HARDWARE INSTALLATION	7
	C. IP ASSIGNMENT	10
	D. INSTALL ACTIVE X CONTROL:.....	13
IV.	LIVE VIDEO.....	15
V.	IP CAMERA CONFIGURATION.....	17
	A. SYSTEM	18
	B. NETWORK	21
	C. A/V SETTING	25
	D. EVENT LIST.....	32
VI.	NETWORK CONFIGURATION.....	36
VII.	FACTORY DEFAULT	38
VIII.	PACKAGE CONTENTS	38
	APPENDIX I.....	39

I. Preface

IP Vandal Dome is a professional CMOS Mega Pixel IP Vandal Dome. It has built-in web server which enables user to view real-time video via IE browser. It also supports simultaneously MPEG-4&JPEG video compression with CMOS M-Pixel Sensor which provides smooth and high video quality. The video can be stored in the SD card, and can be playback remotely.

IP Vandal Dome is an easy-to-use IP Camera which is designed for security application.

II. Product Specifications

- Support IP66 (Weatherproof)
- Support PoE (Power Over Ethernet) - Optional
- Vandal Proof (Polycarbonate shell withstand impact up to 400 pounds)
- MPEG4/ JPEG compression
- Supports SD card for local recording
- 2-way audio
- Support Cell Phone/PDA/3GPP
- Online firmware upgrade

Specifications

Hardware	
Model	HLV-1CM
Image sensor	1/4" CMOS ,1.5 lux
Lens Changeable	Vari-focal lens 3.7~12mm
CPU	ARM 9 ,32 bit RISC
SDRAM	64MB
Flash	8MB
I/O	1 in/ 1 Relay out (COM. & N.O.)
Audio in	1
Audio Out	1

Power over Ethernet (PoE)	Optional
Power Consumption	DC 12V, 490mA
Dimensions	126mm (W) x 126mm (L) x 100mm (D)
Network	
Ethernet	10/ 100 Base-T
Network Protocol	HTTP, TCP/ IP, SMTP, FTP, PPPoE, DHCP, DDNS, NTP, UPnP, 3GPP
System	
Video Resolution	1280x1024, 640x480, 320x240, 160x120
Video adjust	Brightness, Contrast, exposure, sharpness
Dual Streaming	Yes
Image snapshot	Yes
Full screen monitoring	Yes
Compression format	MPEG-4/ JPEG
Video bitrate adjust	CBR, VBR
Motion Detection	Yes, 3 different areas
Triggered action	Mail, FTP, Save to SD card
Pre/ Post alarm	Yes, configurable
Security	Password protection
Firmware upgrade	HTTP mode, can be upgraded remotely
Simultaneous connection	Up to 10
Audio	Yes, 2-way
SD card management	
Recording trigger	Motion Detection, IP check, Network Status (wire connection only)
Video format	AVI, JPEG
Video playback	Yes
Delete files	Yes
Web browsing requirement	
OS	Windows 2000, XP, 2003, Microsoft IE 6.0 or above
Hardware	Suggested
	Minimum
	Intel-C 2.0G, RAM: 512MB, Graphic card: 64MB
	Intel-C 1.6G, RAM: 256MB, Graphic card: 32MB

III. Product Installation

A. Monitor Setting

- i. Right-Click on the desktop. Select “ Properties”.



- ii. Change color quality to highest (32bit).

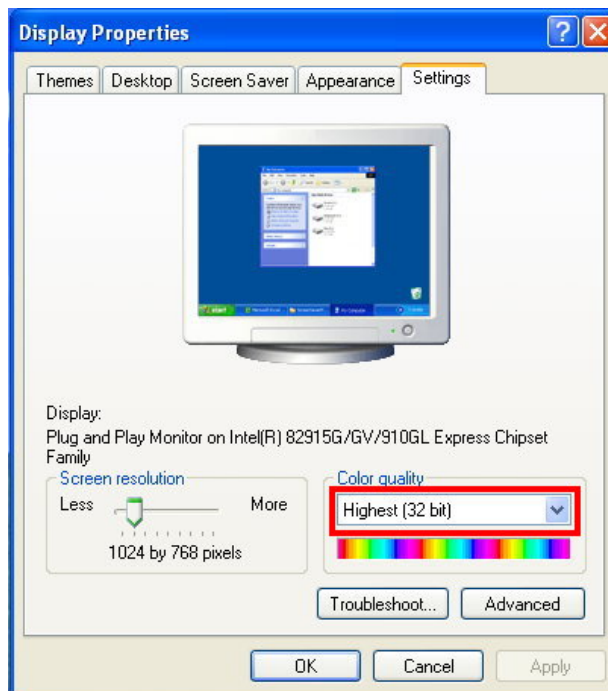

B. Hardware Installation

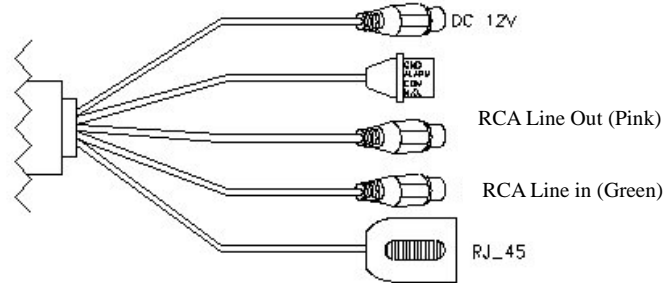

- i. Connect power adaptor
- ii. Connect Ethernet cable to IP Camera
- iii. Connect IP Camera to a computer or Local network.

B-1 I/O Control Instruction

I/O terminal connector – used in application, for e.g., motion detection, event triggering, alarm notifications. It provides the interface to:

1 Digital Input (GND+Alarm) – An alarm input for connecting devices that can toggle between an open and closed circuit, for example: PIRs, door/window contacts, glass break detectors, etc. When a signal is received the state changes and the input becomes active.

1 Relay output (COM +N.O.) – An output to Relay switch, for example: LEDs, Sirens, etc

Digital Input

Alarm Input

1. GND (Ground) : Initial state is LOW
2. Alarm : Max. 50mA, 12VDC

Relay Output

1. COM: (Common)
2. N.O. (Normally Open): Max. 1A, 24VDC or 0.5A, 125VAC

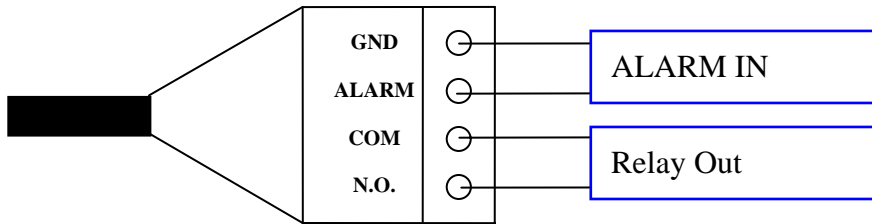

B-2 Relay Connection:
Digital Input connection

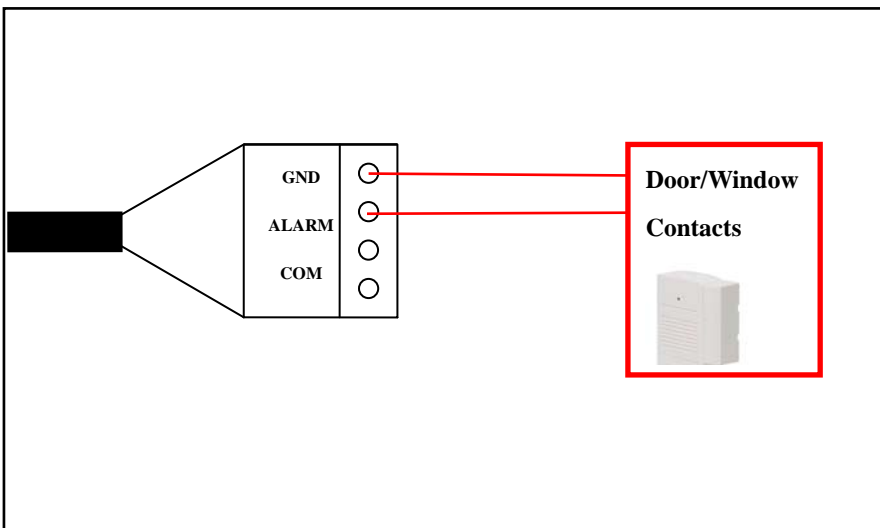

Relay Output Connection

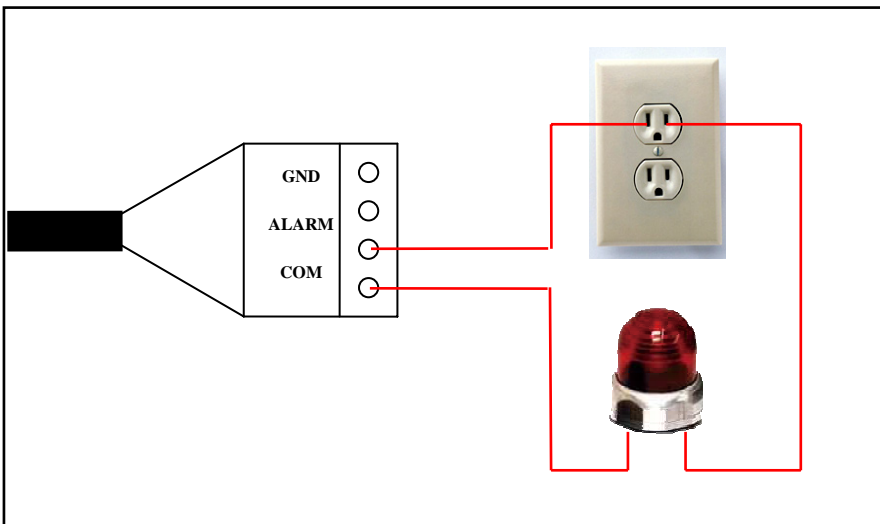

B-3 Power Over Ethernet PoE – (Optional) 802.3af, 15.4W PoE Switch is recommended

Power over Ethernet (PoE) is a technology that integrates power into a standard LAN infrastructure. It enables power to be provided to the network device, such as an IP phone or a network camera, using the same cable as that used for network connection. It eliminates the need for power outlets at the camera locations and enables easier application of uninterruptible power supplies (UPS) to ensure 24 hours a day, 7 days a week operation.

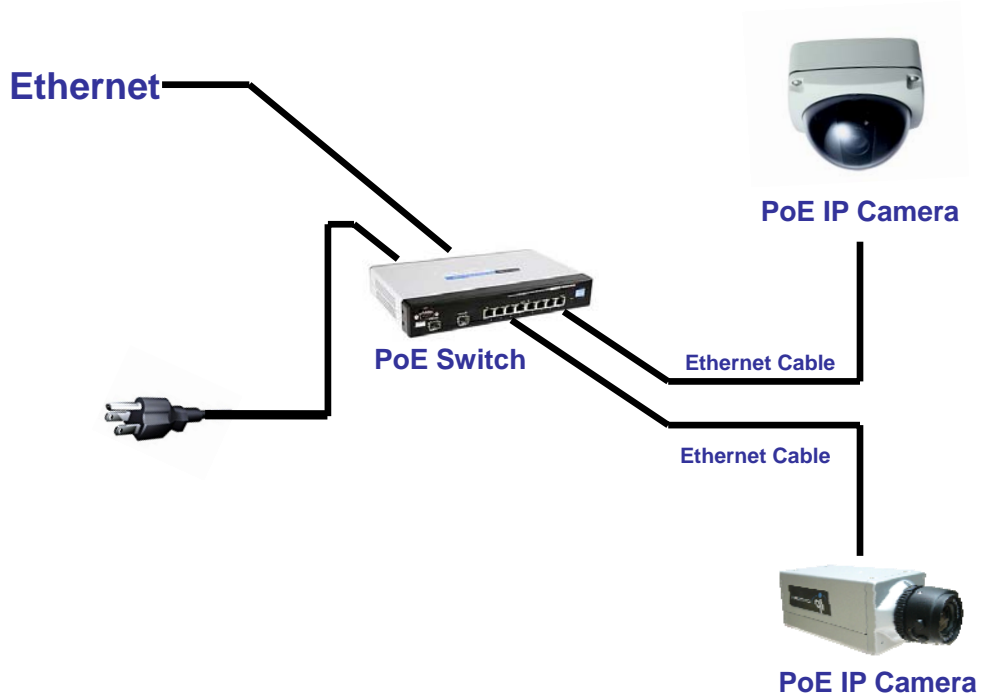

C. IP Assignment

- i. Use the software, “IP Installer” to assign the IP address of IP Camera. The software is in the attached software CD.
- ii. There are two languages for the IP installer
 - a. IPInstallerCht.exe : Chinese version
 - b. IPInstallerEng.exe : English version
- iii. There are 3 kinds of IP configuration.
 - a. Fixed IP (Public IP or Virtual IP)
 - b. DHCP (Dynamic IP)
 - c. Dial-up (PPPoE)
- iv. Please execute IP Installer
- v. For Windows XP SP2 user, the following message box may appear. Please click “Unblock”.



- vi. IP Installer configuration:

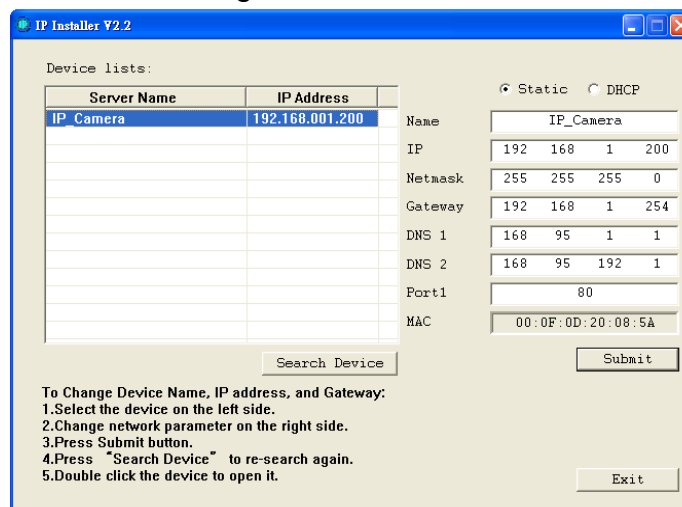

- vii. IP Installer will search all IP Cameras connected on Lan. The user can click “Search Device” to search again.
- viii. Click one of the IP Camera listed on the left side. The network configuration of this IP camera will show on the right side. You may change the “name” of the IP Camera to your preference (eg: Office, warehouse). Change the parameter and click “Submit”. The following dialogue box will show. Just click “OK”. It will apply the change and reboot the Device.

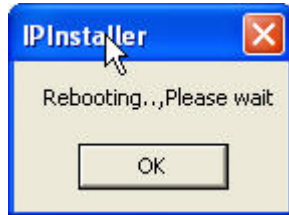

- ix. Please make sure the subnet of PC IP address and IP CAM IP address are the same.

The same Subnet:

IP CAM IP address: 192.168.1.200

PC IP address: 192.168.1.100

Different Subnets:

IP CAM IP address: 192.168.2.200

PC IP address: 192.168.1.100

To Change PC IP address:

Control Panel → Network Connections → Local Area Connection Properties → Internet Protocol (TCP/IP) → Properties

Please make sure your IP Camera and PC have the same Subnet. If not, please change IP Camera subnet or PC IP subnet accordingly.

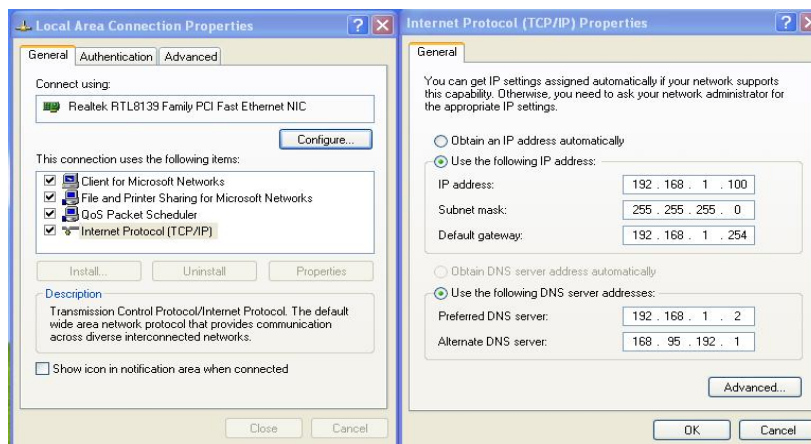

- x. A quick way to access remote monitoring is to left-click the mouse twice

on a selected IP Camera listed on “Device list” of IP Installer. An IE browser will be opened.

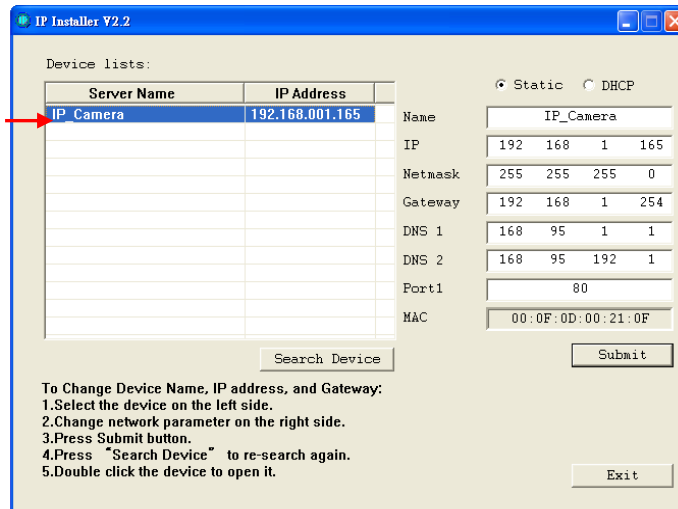

- xi. Then, please key in the default “user name: admin” and “password: admin”.



D. Install ActiveX control:

For the first time to view the camera video via IE, it will ask you to install the ActiveX component.

If the installation failed, please check the security setting for the IE browser.

- i. IE → Tools → Internet Options... → Security Tab → Custom Level... → Security Settings → Download unsigned ActiveX controls → Select “Enable” or Prompt.
- ii. IE → Tools → Internet Options... → Security Tab → Custom Level... → Initialize and script ActiveX controls not marked as safe → Select “Enable” or Prompt.

1

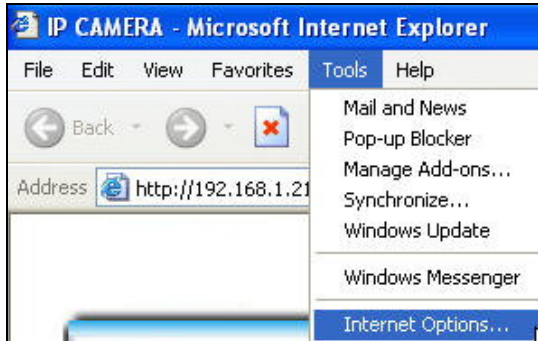

2

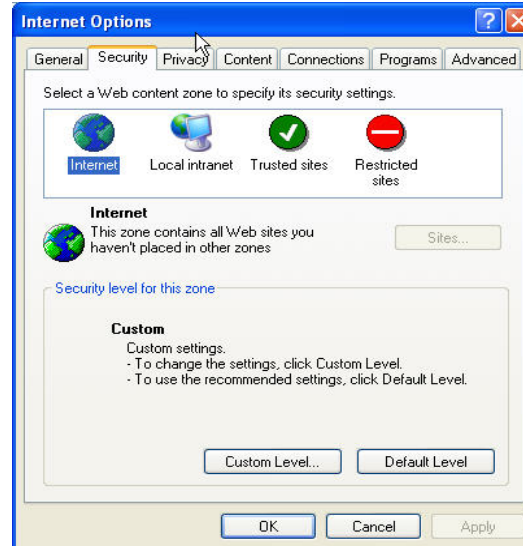

3

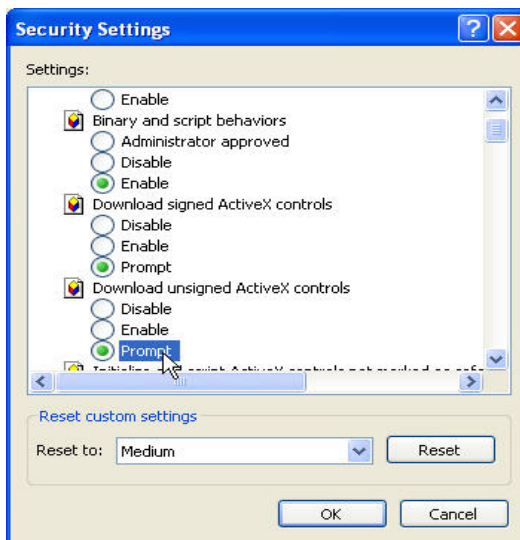

4

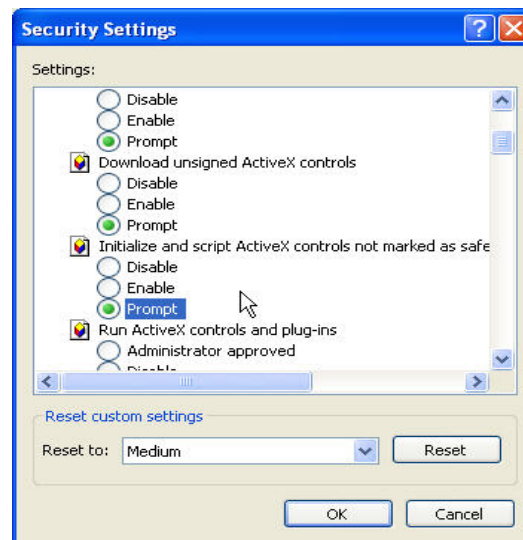

5

When popup the following dialogue box, click “Yes”.

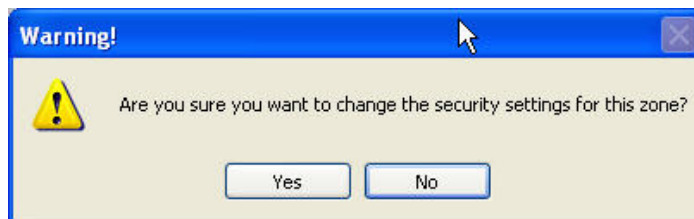

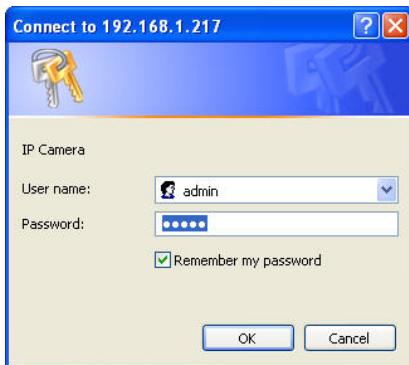

IV. Live Video

Start an IE browser, type the IP address of the IP Camera in the address field. It will show the following dialogue box. Key-in the user name and password. The default user name and password are “**admin**” and “**admin**”.

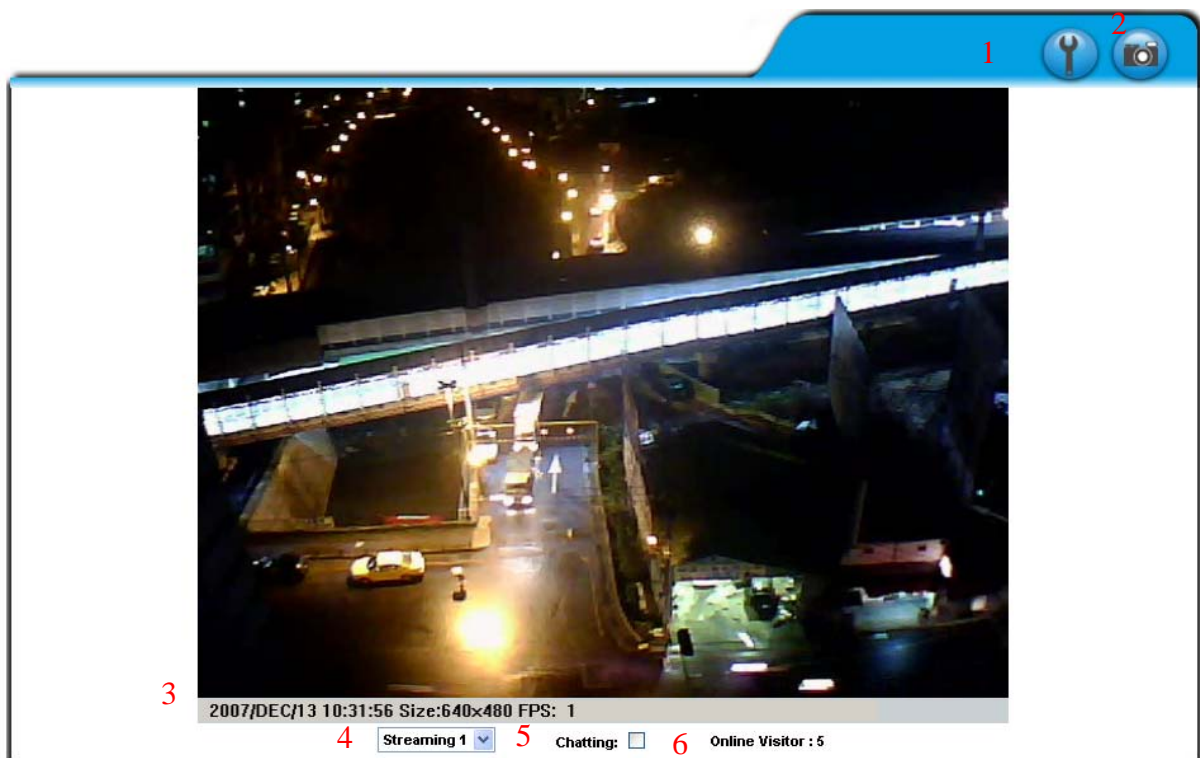

When connect to the IP Camera ,The following program interface shows.



1.  : Get into the administration page
2.  : Video Snapshot
3. Show system time, video resolution, and video refreshing rate
4. Select streaming source (When streaming 2 is disabled, this option will not show)
5. IP Camera supports 2-way audio. Click the “Chatting” check box. Then you can use microphone which connects to the PC to talk to server side, which is IP Camera side
6. Shows how many people connect to this IP camera
7. Control the relay which is connected to this camera.



Double-click the video, it will change to full screen mode. Press “Esc” or double-click the video again, it will change back to normal mode.

Right-Click the mouse on the video, it will show a pop-up menu.



1. Snapshot : Save a jpg picture
2. Record Start : Record video in the local PC. It will ask you where to save the video. To stop recording, right-click the mouse again. Select “Record Stop”. The video format is AVI. Use Microsoft Media Player to play the recorded file.
3. Mute : Turn of the audio. Click again to turn on it.
4. Full Screen : Full-screen mode.

V. IP Camera Configuration

Click  to get into the administration page. Click  to back to the live video page.



The screenshot shows the configuration page for an IP camera. On the left is a navigation menu with categories: System (System Information, User Management, System Update), Network (IP Setting, PPPoE, DDNS), A/V Setting (Image Setting, Video Setting, Audio), and Event List (Event Setting, I/O Setting, Mail & FTP, SD Card, Log List). The main content area is titled 'System Information' and contains the following settings:

- Server Information**
 - Server Name:
 - MAC Address:
 - Language: English 繁體中文 简体中文
- Overlay Setting**
 - Enabled Disabled
 - Position: Top-Left Top-Right Bottom-Left Bottom-Right
- Time Setting**
 - Server Time: 2007/5/8 10:52:44 Time Zone: GMT+08:00
 - Date Format: yy/mm/dd mm/dd/yy dd/mm/yy
 - Time zone:
 - NTP :
 - NTP Server :
 - Synchronize with PC's time
 - Date :
 - Time :
 - Manual
 - Date :
 - Time :
 - The date and time remain the same

An 'Apply' button is located at the bottom right of the configuration area.

A. System

i. System Information

- a. Server Information : Set up the camera name, select language, and set up the camera time.
 1. Server Name : This is the Camera name. This name will show on the IP Installer.
 2. Select language : There are English, Traditional Chinese, and Simple Chinese to select. When changed, it will show the following dialogue box for the confirmation of changing language.



- b. Overlay Setting : select a position where date & time display on screen.



- c. Server time setting : Select options to set up time - "NTP", "Synchronize with PC's time", "Manual", "The date and time remain the same".

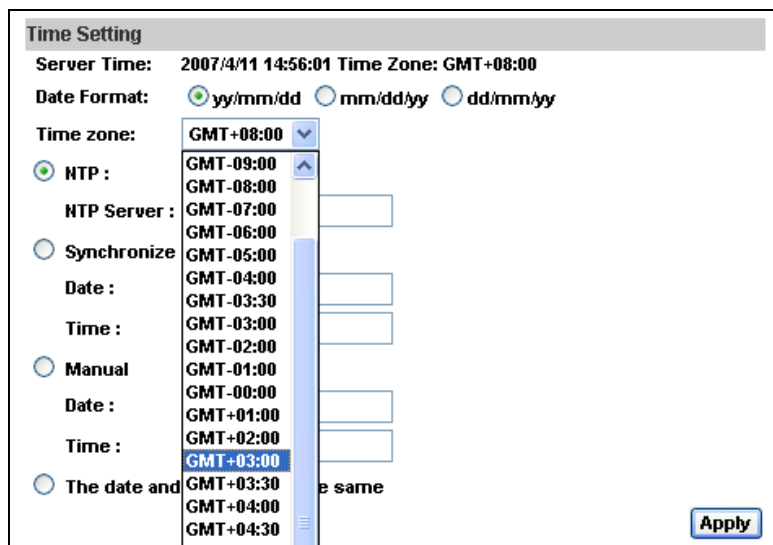

ii · User Management

IP Camera supports three different users, administrator, general user, and anonymous user.

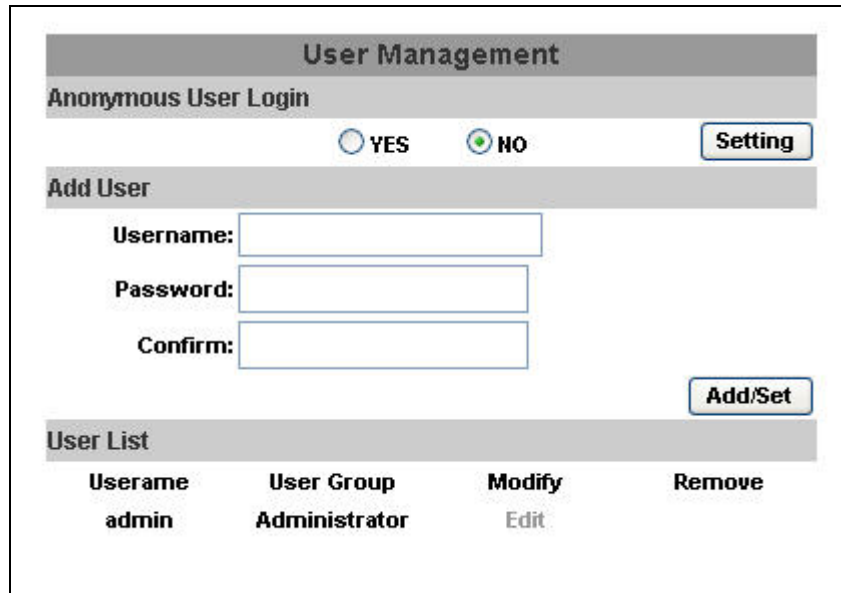

The screenshot shows the 'User Management' web interface. It has a title bar 'User Management' and a section 'Anonymous User Login' with radio buttons for 'YES' and 'NO' (where 'NO' is selected) and a 'Setting' button. Below is the 'Add User' section with input fields for 'Username:', 'Password:', and 'Confirm:', and an 'Add/Set' button. At the bottom is the 'User List' section with a table:

Username	User Group	Modify	Remove
admin	Administrator	Edit	

- Anonymous User Login :
Yes : Allow anonymous login
No : Need user name & password to access this IP camera
- Add user :
Type the user name and password, then click "Add/Set".
- Click "edit" or "delete" to modify the user.



The screenshot shows a 'User Setup' dialog box within a Microsoft Internet Explorer window. The dialog has a title bar 'User_Setting - Microsoft Internet Explorer'. It contains input fields for 'Username:' (with 'admin' entered), 'Password:', and 'Confirm:', and an 'OK' button.

iii、System update：

System Update	
Firmware Upgrade	
Firmware Version:	V3.2.11
New Firmware:	<input type="text"/> 瀏覽...
<input type="button" value="Upgrade"/>	
Reboot System	
<input type="button" value="Start"/>	
Factory Default	
<input type="button" value="Start"/>	
Setting Management	
Save As a File:	Right click the mouse button on Setting Download and then select Save As... to save current system's setting in the PC.
New Setting File:	<input type="text"/> 瀏覽...
<input type="button" value="Upgrade"/>	

- a. To update the firmware online, click “Browse...” to select the firmware. Then click “Upgrade” to the proceed.
- b. Reboot system：re-start the IP camera
- c. Factory default：delete all the settings and restore defaults system.
- d. Setting Management：User may download the current setting to PC, or upgrade from previous saved setting.
 1. Setting download:
Right-click the mouse button on Setting Download → Select “Save AS...” to save current IP CAM setting in PC → Select saving directory → Save
 2. Upgrade from previous setting
Browse → search previous setting → open → upgrade → Setting update confirm → click **index.html**. to return to main page

B.Network

i. IP Setting

IP Vandal Dome supports DHCP and static IP.

IP Setting	
IP Assignment	
<input type="radio"/> DHCP	
<input checked="" type="radio"/> Static	
IP Address:	<input type="text" value="192.168.1.200"/>
Subnet Mask:	<input type="text" value="255.255.255.0"/>
Gateway:	<input type="text" value="192.168.1.254"/>
DNS 0:	<input type="text" value="168.95.1.1"/>
DNS 1:	<input type="text" value="168.95.192.1"/>
Port Assignment	
Web Page Port:	<input type="text" value="80"/>
RTSP Port :	<input type="text" value="554"/>
RTP Start Port:	<input type="text" value="5000"/> [1024..10000]
RTP End port:	<input type="text" value="9000"/> [1025..10000]
UPnP	
UPnP:	<input checked="" type="radio"/> Enabled <input type="radio"/> Disabled
<input type="button" value="Apply"/>	

- a. DHCP : Using DHCP, IP Vandal Dome will get all the network parameters automatically.
- b. Static IP : Please type in IP address, subnet mask, gateway, and DNS manually.
- c. Port Assignment: user may need to assign different port to avoid conflict when setting up IP assignment.
 1. Web Page Port: setup web page connecting port and video transmitting port (Default: 80)
 2. RTSP Port: setup port for RTSP transmitting (Default: 554)
 3. RTP Start and End Port: in RTSP mode, you may use TCP and UDP for connecting. TCP connection uses RTSP Port (554). UDP connection uses RTP Start and End Port.

d. UPnP

This IP camera supports UPnP, If this service is enabled on your computer, the camera will automatically be detected and a new icon will be added to “My Network Places.”

Note: UPnP must be enabled on your computer.

Please follow the procedure to activate UPnP

1. open the Control Panel from the Start Menu
2. select Add/Remove Programs
3. Select Add/Remove Windows Components and open Networking Services section
4. Click Details and select UPnP to setup the service
5. The IP device icon will be added to “MY Network Places”
6. User may double click the IP device icon to access IE browser

ii \ PPPoE :

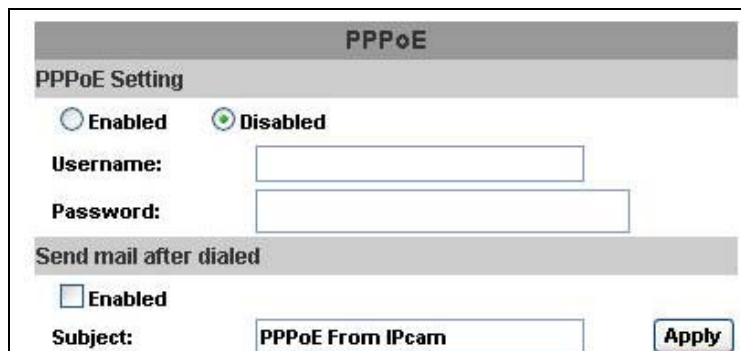

Select “Enabled” to use PPPoE.

Key-in Username and password for the ADSL connection.

Send mail after dialed : When connect to the internet, it will send a mail to a specific mail account. For the mail setting, please refer to “Mail and FTP” settings.

iii \ DDNS :

IP Vandal Dome supports DDNS (Dynamic DNS) service.

a. DynDNS :

DDNS

DDNS Setting

Enabled Disabled

Provider:

Hostname:

Username:

Password:

Schedule Update: **Minutes**

State

Idle

Note:

1. **Schedule Update:** Feature of DDNS schedule update is designed for IP products which installed behind the ICS or NAT devices. Update range from every 5 (minutes) to 5000 (minutes) and 0 remain to off.
2. Please note that the hostname will be blocked by DynDNS.org if schedule update is more than once every 5 minutes to 60 minutes. In general, schedule update in every 1440 minutes is recommended.

1. Please enable this service
2. Key-in the DynDNS server name, user name, and password.
3. Set up the IP Schedule update refreshing rate.
4. Click “Apply”
5. If setting up IP schedule update too frequently, the IP may be blocked. In general, schedule update every day (1440 minutes) is recommended.

b. Camddns service :

DDNS

DDNS Setting

Enabled Disabled

Provider: ▼

Username:

Schedule Update: Minutes

State

Idle

Note:

- Schedule Update:** Feature of DDNS schedule update is designed for IP products which installed behind the ICS or NAT devices. Update range from every 5 (minutes) to 5000 (minutes) and 0 remain to off.
- Please note that the hostname will be blocked by DynDNS.org if schedule update is more than once every 5 minutes to 60 minutes. In general, schedule update in every 1440 minutes is recommended.

1. Please enable this service
2. Key-in user name.
3. IP Schedule update is default at 5 minutes
4. Click “Apply”.

c. DDNS Status

1. Updating : Information update
2. Idle : Stop service
3. DDNS registration successful, can now log by
<http://<username>.ddns.camddns.com> : Register successfully.
4. Update Failed, the name is already registered : The user name has already been used. Please change it.
5. Update Failed, please check your internet connection : Network connection failed.
6. Update Failed, please check the account information you provide : The server, user name, and password may be wrong.

C.A/V Setting

i \ Image Setting

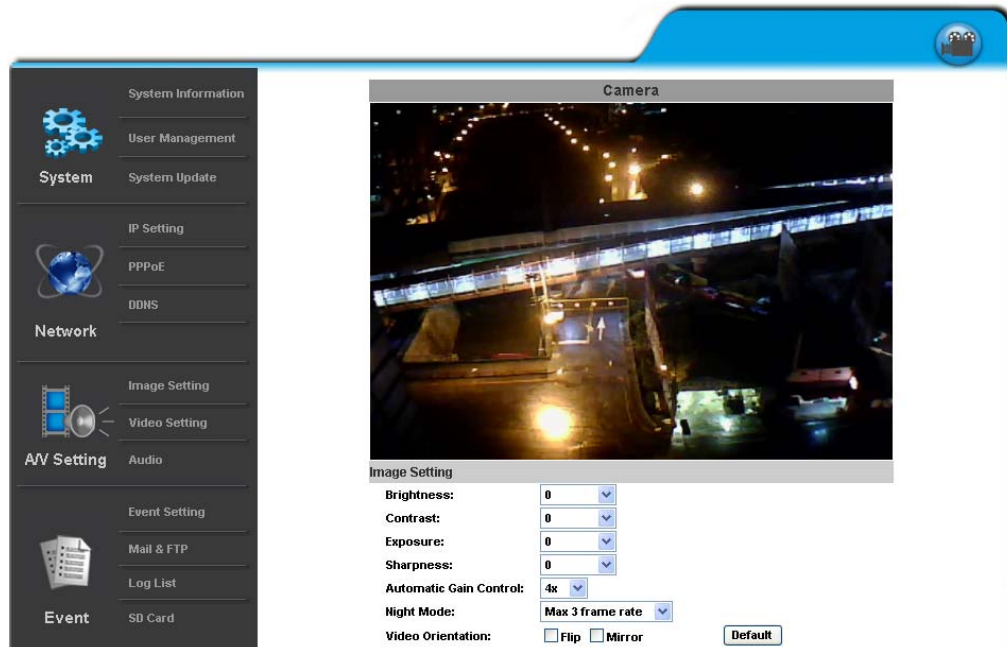

Adjust “Brightness”, “Contrast”, “Hue”, “Saturation” to get clear video. Automatic gain control, night mode, and video orientation are adjustable.

Night mode:

This function can be set at different Frame rate to increase night illumination. Lower the Frame rate set, slower the frame refresh rate, but better the night illumination.

Night mode will be activated automatically depending on lux illumination, if set at 15 frame rate, when night mode activated at night, the frame rate will not be more than 15FPS

ii \ Video Setting

User may select 2 streaming output simultaneously:

Streaming 1 Setting: Basic mode and Advanced mode

Streaming 2 Setting: Basic mode, Advanced mode, and 3GPP mode

(Max Video Frame Rate for both streaming combined is 30 FPS)

a. Streaming 1 Basic Mode :

Video Setting

Streaming 1 Setting

Basic Mode **Advanced Mode**

Resolution: VGA - 640x480 ▼

Quality: Medium ▼

Video Frame Rate: 10 FPS ▼

Video Format: MPEG4 ▼

Video System: 60 Hz ▼

RTSP Path: **ex:rtsp://<<IP>>/ No Audio**

1. Resolution :
There are 4 resolutions to choose.
SXGA – 1280x1024 VGA – 640x480
QVGA – 320x240 QQVGA – 160x120
2. Quality :
There are 5 levels to adjust. The higher the quality is, the bigger the file size is.
3. Video Frame Rate:
The video refreshing rate per second
[Max 30 FPS \(10FPS at resolution 1280x1024\)](#)
4. Video Format :
There are 2 Video Formats to choose
MPEG4 or JPEG.
5. Video System :
Please select 60 (Hz) if you are in America, Taiwan...
Please select 50 (Hz) if you are in Europe, China...
6. RTSP Path: RTSP output name

b. Streaming 1 Advanced Mode :

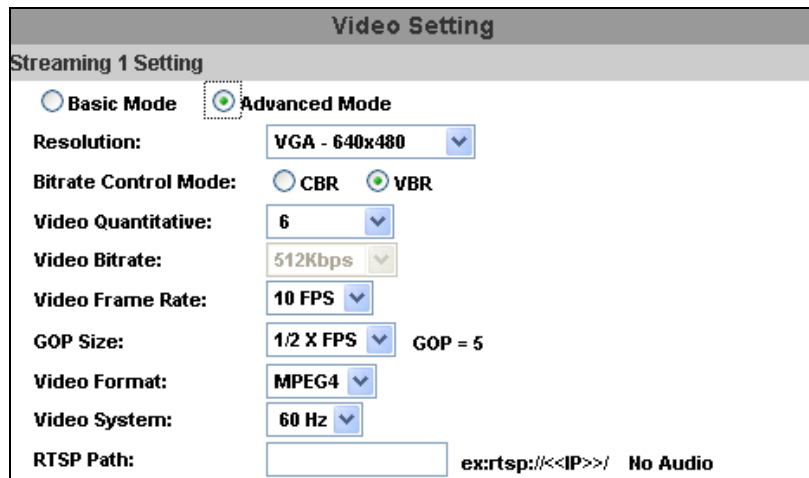

The screenshot shows the 'Video Setting' window for 'Streaming 1 Setting'. The 'Advanced Mode' radio button is selected. The settings are as follows:

- Resolution: VGA - 640x480
- Bitrate Control Mode: VBR
- Video Quantitative: 6
- Video Bitrate: 512Kbps
- Video Frame Rate: 10 FPS
- GOP Size: 1/2 X FPS (GOP = 5)
- Video Format: MPEG4
- Video System: 60 Hz
- RTSP Path: [Empty field] ex:rtsp://<<IP>>/ No Audio

1. Resolution :

There are 4 resolutions to choose.

- | | |
|------------------|-----------------|
| SXGA – 1280x1024 | VGA – 640x480 |
| QVGA – 320x240 | QQVGA – 160x120 |

2. Bitrate Control Mode

There are CBR [Constant Bit Rate] and VBR [Variable Bit Rate] to use.

CBR : 32Kbps~4Mbps (the higher the CBR is, the better the video quality is , vice versa)

VBR : 1~10 (Compression Rate)

3. Video Frame Rate

The video refreshing rate per second.

[Max 30 FPS \(10FPS at resolution 1280x1024\)](#)

4. GOP Size

It means "Group of Pictures". (The higher the GOP is, the better the quality is, vice versa)

5. Video Format : MPEG4 or JPEG

7. Video System :

Please select 60 (Hz) if you are in America, Taiwan...

Please select 50 (Hz) if you are in Europe, China...

6. RTSP Path: RTSP output name

c. Streaming 2 Basic Mode :

(Dual Streaming is supported only when resolution is set at VGA or below)

Streaming 2 Setting

Basic Mode Advanced Mode 3GPP Mode Close

Resolution:

Quality:

Video Frame Rate:

Video Format:

RTSP Path: `ex:rtsp://<<IP>>/v2` **No Audio**

1. Resolution :

There are 4 resolutions to choose.

SXGA – 1280×1024 VGA – 640×480
QVGA – 320×240 QQQVGA – 160×120

2. Quality :

There are 5 levels to adjust. The higher the quality is, the bigger the file size is.

3. Video Frame Rate:

The video refreshing rate per second

4. Video Format :

There are 2 Video Formats to choose
MPEG4 or JPEG.

5. RTSP Path: RTSP output name

d. Streaming 2 Advanced Mode :

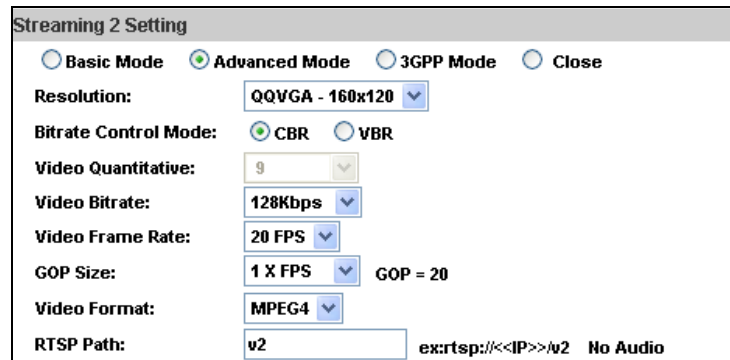

The screenshot shows the 'Streaming 2 Setting' dialog box with the following configuration:

- Mode: Basic Mode, Advanced Mode, 3GPP Mode, Close
- Resolution: QVGA - 160x120
- Bitrate Control Mode: CBR, VBR
- Video Quantitative: 9
- Video Bitrate: 128Kbps
- Video Frame Rate: 20 FPS
- GOP Size: 1 X FPS, GOP = 20
- Video Format: MPEG4
- RTSP Path: v2, ex:rtsp://<<IP>>/v2 No Audio

1. Resolution :

There are 4 resolutions to choose.

SXGA – 1280x1024

VGA – 640x480

QVGA – 320x240

QQVGA – 160x120

2. Bitrate Control Mode

There are CBR [Constant Bit Rate] and VBR [Variable Bit Rate] to use.

CBR : 32Kbps~4Mbps (the higher the CBR is, the better the video quality is)

VBR : 1~10 (Compression Rate)

3. Video Frame Rate

The video refreshing rate per second.

4. GOP Size

It means "Group of Pictures". The higher the GOP is, the better the quality is.

5. Video Format : MPEG4 or JPEG

6. RTSP Path: RTSP output name

e. Streaming 2, 3GPP mode:

Streaming 2 Setting

Basic Mode
 Advanced Mode
 3GPP Mode
 Close

Resolution:

Bitrate Control Mode: CBR VBR

Video Quantitative:

Video Bitrate:

Video Frame Rate:

GOP Size: **GOP = 20**

Video Format:

3GPP Path: **ex:rtsp://<<IP>>/3g Audio:AMR**
ex:rtsp://<<IP>>/3gx No Audio

3GPP default value is QQVGA , 128Kbp , 5FPS , GOP=1XFPS

3GPP mode suggested setting: QQVGA, lower than 128kbps, 5FPS, GOP= 1x FPS or 2x FPS, MPEG4 format

3GPP can achieve up to 10FPS, In 3GPP mode, Stream 1 & Stream 2 combined frame rate is 20FPS

1. Fix Resolution :
QQVGA – 160x120
2. Bitrate Control Mode
There are CBR [Constant Bit Rate] and VBR [Variable Bit Rate] to use.
CBR : 32Kbps~320bps (the higher the CBR is, the better the video quality is)
VBR : 1~10 (Compression Rate)
3. Video Frame Rate (**5 FPS is recommended**)
The video refreshing rate per second.
4. GOP Size
It means "Group of Pictures". The higher the GOP is, the better the quality is.
5. Video Format : MPEG4 or JPEG
6. 3GPP: 3GPP output name

iii 、 Audio :

IP Vandal Dome supports 2-way audio.

- a. For IP camera to local PC, select “Enable” to start this function (When enabled, you can send audio via external mic in the IP Camera)

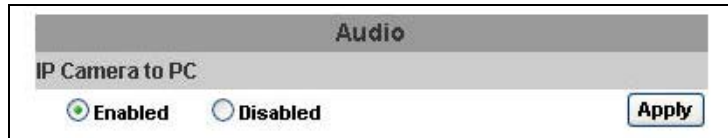

- b. For local PC to IP camera, check “chatting” in the browsing page (You will need a mic to send audio from local PC to IP Camera)



The Audio will not be smooth when enable SD card recording function simultaneously.

D.Event List

IP Vandal Dome provides multiple event settings.

i、 Event Setting

Event Setting

Motion Detection

Area Setting: Area 1 Area 2 Area 3

Sensitivity: 10(High) 10(High) 8

Area 1: E-mail FTP Save to SD card

Area 2: E-mail FTP Save to SD card

Area 3: E-mail FTP Save to SD card

Subject: IP Camera Warning!

Interval: 10 sec a period of time between every two motions detected.

Record File

File Format: JPEG Files(with Record Time Setting)*Only with JPEG Compression Format.

Record Time Setting: AVI File(with Record Time Setting)

Pre Alarm: JPEG Files(with Record Time Setting)*Only with JPEG Compression Format.

JPEG File(Single File with Interval Setting)

Network Dis-connected

Dis-connected: Save to SD card

Network IP Check

IP Check: Enabled Disabled

IP Address: www.google.com

Interval: 30 sec

IP Check: Save to SD card

Apply

a. Motion Detection

IP CAMERA allows 3 areas motion detection. When motion is triggered, it can send video to some specific mail addresses, transmit video to remote ftp server, trigger the relay, and save video to local SD card. To set up the motion area, click “Area Setting”. Using mouse to drag and set the area. The same operation for area 2 and 3.

- b. Record File Setting: It provides 3 kinds of recording file type
 1. AVI file (with record time Setting)
 2. JPEG file (with record time setting) only with JPEG compression format
 3. JPEG file (single file with interval setting)
- c. Record Time Setting : Pre Alarm and Post Alarm setups for video start and end time when motion detected, I/O, or other devices got triggered.

Note: Pre/Post Alarm record time is base on record time setting and IP Cam built-in Ram memory. Limited by IP Cam built-in Ram Memory, When information is too much or video quality set too high, it will cause recording frame drop or decrease on post alarm recording time.

- d. Network Dis-connected
When the network is down, it will save the video to local SD card.
This function is only enabled in wire connection.
- e. Network IP check
For the use of recording software, IP CAMERA supports the detection of network connection. Whenever the connection is down, it records the video to SD card. To use this function, key in the IP address of the PC which is installed in the recording software, and enable the function of “Save to SD card”, then click “Apply”.

The interval of two video files on SD card is fixed with 30 seconds.

ii - I/O Setting

IP Camera supports 1 input/ 1 output.

- a. Input Action: When input is triggered, it can send the video to some specific mail addresses, transmit the video to remote ftp server, trigger the relay, and save video to local SD card.
- b. Output Setting:
OnOff Switch mode – Output On or Off to relay
Time Switch mode – Output interval to relay can be set

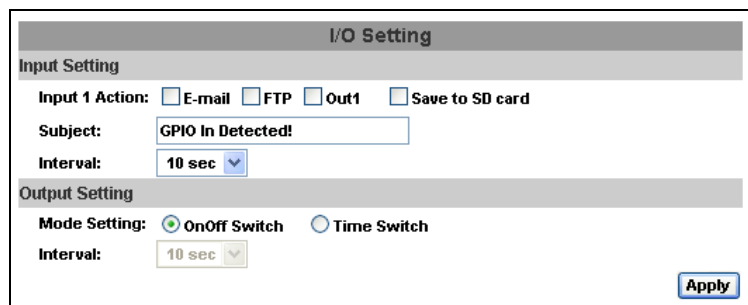

iii 、 Mail & FTP

To send out the video via mail of ftp, please set up the configuration first.

Mail & FTP	
Mail Setting	
Mail Server:	<input type="text"/>
Username:	<input type="text"/>
Password:	<input type="text"/>
Sender's Mail:	<input type="text"/>
Receiver's Mail:	<input type="text"/>
Bcc Mail:	<input type="text"/>
FTP Setting	
FTP Server:	<input type="text"/>
Username:	<input type="text"/>
Password:	<input type="text"/>
Port:	<input type="text" value="21"/>
Path:	<input type="text" value="/"/>
<input type="button" value="Apply"/>	

iv 、 SD card

Please Insert SD card before use it. Make sure pushing SD card into the slot completely.

Note : The use of the SD card will affect the operation of the IP Vandal Dome slightly, such as affecting the frame rate of the



a. Playback :



1. It will show the capacity of the SD card. Click the date listed on this page. It will show the list of the video.

2006/04/17			Del
Time	Video	Event Type	<input type="checkbox"/>
09:05:22	090522f.avi	Network Dis-connected	<input type="checkbox"/>
09:05:52	090552f.avi	Network Dis-connected	<input type="checkbox"/>
09:06:22	090622f.avi	Network Dis-connected	<input type="checkbox"/>
09:06:52	090652f.avi	Network Dis-connected	<input type="checkbox"/>
09:07:22	090722f.avi	Network Dis-connected	<input type="checkbox"/>
09:07:52	090752f.avi	Network Dis-connected	<input type="checkbox"/>
09:08:22	090822f.avi	Network Dis-connected	<input type="checkbox"/>
09:08:51	090851f.avi	Network Dis-connected	<input type="checkbox"/>
09:09:21	090921f.avi	Network Dis-connected	<input type="checkbox"/>
09:09:51	090951f.avi	Network Dis-connected	<input type="checkbox"/>

1 2 3 4 5

2. The video format is AVI. Click the video to start Microsoft Media Player to play it.
3. To delete the video, check it, then click **Del**. When the SD card is full, it will remove the oldest video automatically.

v 、 Log List

Log List	
System Logs	Logs
Motion Detection Logs	Logs
I/O Logs	Logs
All Logs	Logs

Sort by System Logs, Motion Detection Logs and I/O Logs. In addition, System Logs and I/O Logs won't lose data due to power failure.

VI. Network Configuration

i. Configuration 1 :

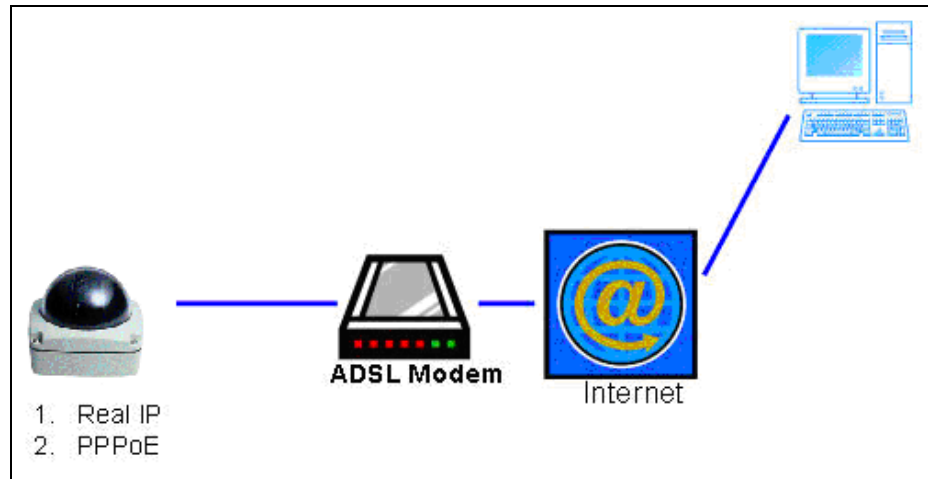

- a. Internet Access : ADSL or Cable Modem
- b. IP address : One real IP or one dynamic IP
- c. Only IP Vandal Dome connects to the internet
- d. For fixed real IP, set up the IP into IP Vandal Dome. For dynamic IP, start PPPoE.

ii. Configuration 2 :

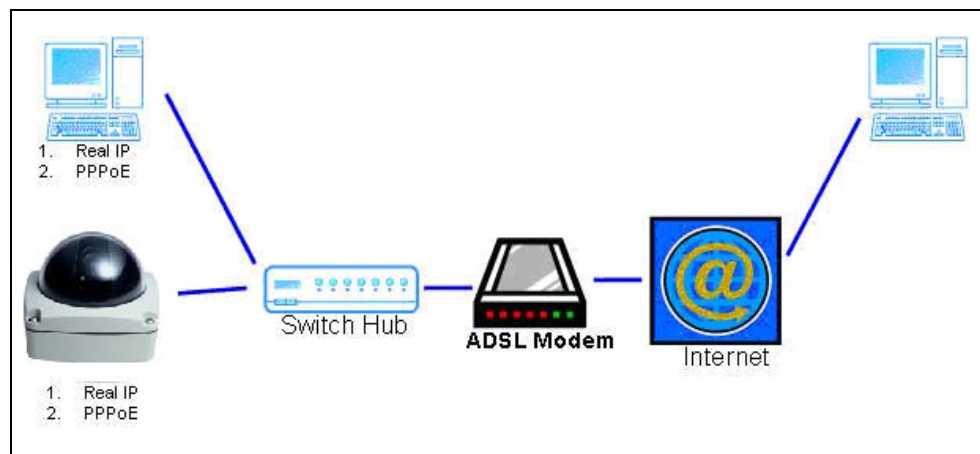

- a. Internet Access : ADSL or Cable Modem
- b. IP address : More than one real IP or one dynamic IP
- c. IP Vandal Dome and PC connect to the internet
- d. Device needed : Switch Hub
- e. For fixed real IP, set up the IP into IP Vandal Dome and PC. For dynamic IP, start PPPoE.

iii 、 Configuration 3 :

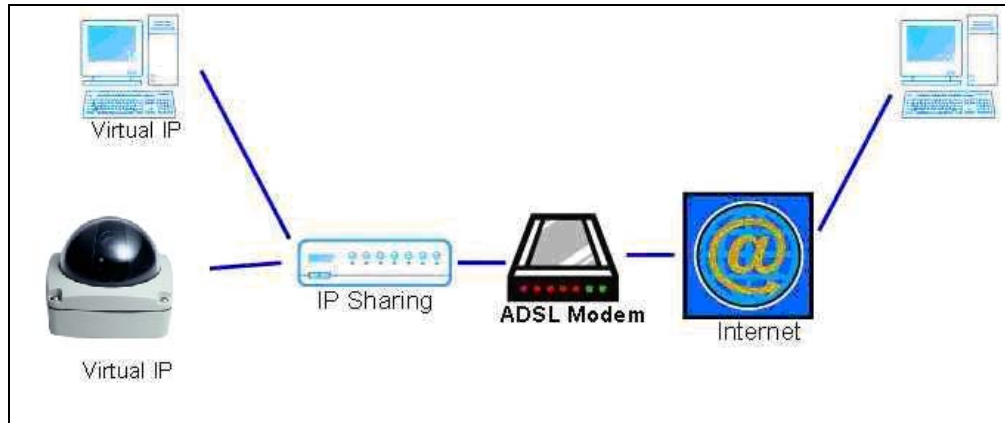

- a. Internet Access : ADSL or Cable Modem
- b. IP address : one real IP or one dynamic IP
- c. IP Vandal Dome and PC connect to the internet
- d. Device needed : IP sharing
- e. Use virtual IP, set up port forwarding in IP sharing.

VII. Factory Default

- i \ To recover the default IP address and password, please follow the following steps.
- ii \ Press and hold the button in the back of IP Vandal Dome.

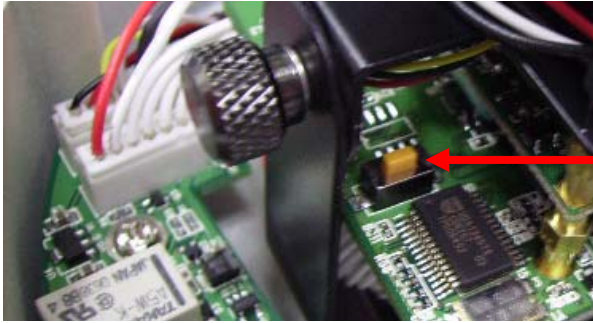

Factory Default

- iii \ Power on the camera. Don't release the button during the system booting.
- iv \ It will take around 30 seconds to boot the camera.
- v \ Release the button when camera finishes proceed.
- vi \ Re-login the camera using the default IP (<http://192.168.1.200>), and user name (admin), password (admin).

VIII. Package contents

- i \ CMOS 1.3 Mega Pixel IP Vandal Dome Camera
- ii \ Adaptor
- iii \ Ethernet Cable
- iv \ CD title (User manual, IP installation Utility)

Appendix I

SD Card Recommended :

SanDisk 128M

SanDisk 256M

SanDisk 512M

SanDisk 1G

SanDisk 2G

SanDisk 4G

Transcend 128M 80X

Transcend 256M 80X

Transcend 512M 80X

Transcend 1G 80X

Transcend 2G 80X

Transcend 4G 80X