

User Manual

IP Camera series





WARNINGS

TO REDUCE THE RISK OF FIRE OR ELECTRIC SHOCK, DO NOT EXPOSE THIS PRODUCT TO RAIN OR MOISTURE.

DO NOT INSERT ANY METALLIC OBJECT THROUGH VENTILATION GRILLS.

CAUTION

	CAUTION RISK OF ELECTRIC SHOCK DO NOT OPEN	
CAUTION : TO REDUCE THE RISK OF ELECTRIC SHOCK. DO NOT REMOVE COVER (OR BACK). NO USER-SERVICEABLE PARTS INSIDE. REFER SERVICING TO QUALIFIED SERVICE PERSONNEL.		

COPYRIGHT

THE TRADEMARKS MENTIONED IN THE MANUAL ARE LEGALLY REGISTERED TO THEIR RESPECTIVE COMPANIES.

Content

I. PREFACE	4
II. PRODUCT SPECIFICATIONS	4
III. PRODUCT INSTALLATION	6
A. MONITOR SETTING.....	6
B. HARDWARE INSTALLATION	7
C. IP ASSIGNMENT	8
D. INSTALL ACTIVE X CONTROL:	11
IV. LIVE VIDEO	13
V. IP CAMERA CONFIGURATION	15
A. SYSTEM	16
B. NETWORK	19
C. A/V SETTING	25
D. EVENT LIST	32
VI. NETWORK CONFIGURATION	35
VII. FACTORY DEFAULT	38
VIII. PACKAGE CONTENTS	38
APPENDIX I	38

V1.0 2008/05/08

I. Preface

IP CAMERA is a CMOS IP camera. It has the web server built in. User can view real-time video via IE browser. it supports MPEG-4 video compression which provides smooth and high video quality. The video can be stored in the SD card and playback remotely.

With user friendly interface, it is an easy-to-use IP camera which is designed for security application.

II. Product Specifications

- MPEG4 compression
- Supports SD card for local recording
- 2-way audio
- Support Dual Streaming
- Supports Cell phone/PDA/3GPP
- Wireless network connection (Optional)
- Power Over Ethernet (Optional)
- Online firmware upgrade
- Real-time video recording

Specifications

Hardware	
CPU	ARM 9 ,32 bit RISC
SDRAM	64MB
Flash	8MB
Image sensor	1/4" CMOS ,1.5 lux
Lens	4.0mm,F2.0
Audio in/ out	1 in/ 1 out
Power Over Ethernet	Yes (Optional)
Power Consumption	LAN: DC 5V, 700mA 3W

		WLAN : DC 5V, 900mA 4W
Dimensions (WxHxD)		67.1 x 111.7 x 50.6 mm
Network		
Ethernet		10/ 100 Base-T
Wireless (Optional)		802.11b/g
WEP		64/ 128 bit
Network Protocol		HTTP, TCP/ IP, SMTP, FTP, PPPoE, DHCP, DDNS, NTP, 3GPP, UPnP
System		
Video Resolution		640x480, 320x240, 160x120
Video adjust		Brightness, Contrast, exposure, sharpness, AGC, BLC, AES
Dual Streaming		Yes
Image snapshot		Yes
Full screen monitoring		Yes
Compression format		MPEG-4
Video bitrate adjust		CBR, VBR
Motion Detection		Yes, 3 different areas
Triggered action		Mail, FTP, Save to SD card
Pre/ Post alarm		Yes, configurable
Security		Password protection
Firmware upgrade		HTTP mode, can be upgraded remotely
Simultaneous connection		Up to 10
Audio		2-ways
SD card management		
Recording trigger		Motion Detection, IP check, Network down (Wire connection only)
Video format		AVI
Video playback		Yes
File Management		Yes, can be deleted or overwrite
Web browsing requirement		
OS		Windows 2000, XP, 2003, IE 6 or above
Hardware	Suggested	Intel-C 2.0G, RAM : 512MB, Graphic card : 64MB
	Minimum	Intel-C 1.6G, RAM : 256MB, Graphic card : 32MB

III. Product Installation

a. Monitor Setting

- i. Right-Click on the desktop. Select “ Properties”



- ii. Change color quality to highest (32bit).

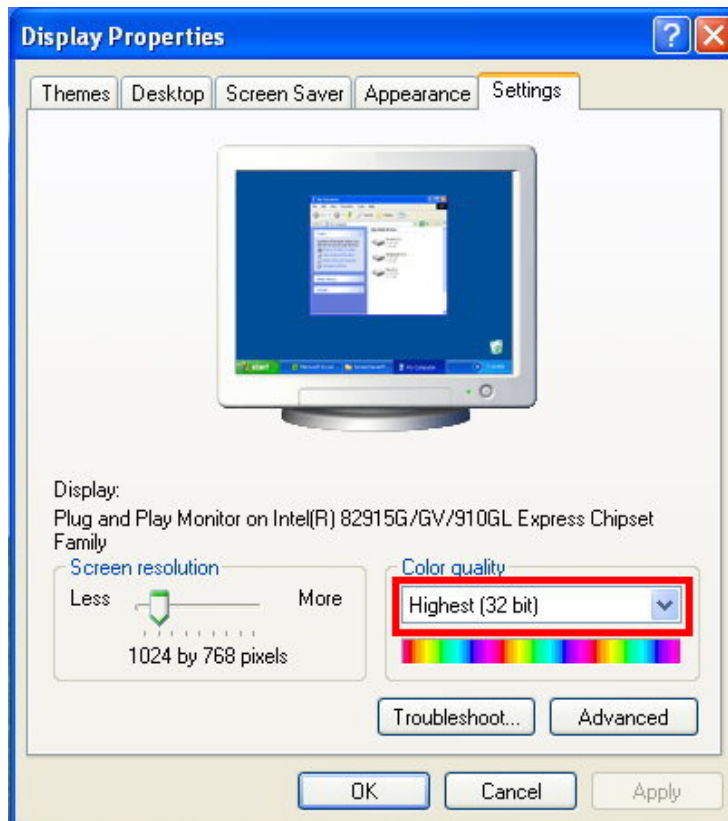

b. Hardware Installation

- i. Connect power adaptor



- ii. Connect IP Camera to PC or Network with Ethernet cable



- iii. Set up the network configurations according to the network environment. For further explanation, please refer to chapter VI, “Network Configuration for IP CAMERA”.
- iv. PoE (Power Over Ethernet)(Optional) **802.3af, 15.4W PoE Switch is recommended**

Power over Ethernet (PoE) is a technology that integrates power into a standard LAN infrastructure. It enables power to be provided to the network device, such as an IP phone or a network camera, using the same cable as that used for network connection. It eliminates the need for power outlets at the camera locations and enables easier application of uninterruptible power supplies (UPS) to ensure 24 hours a day, 7 days a week operation.

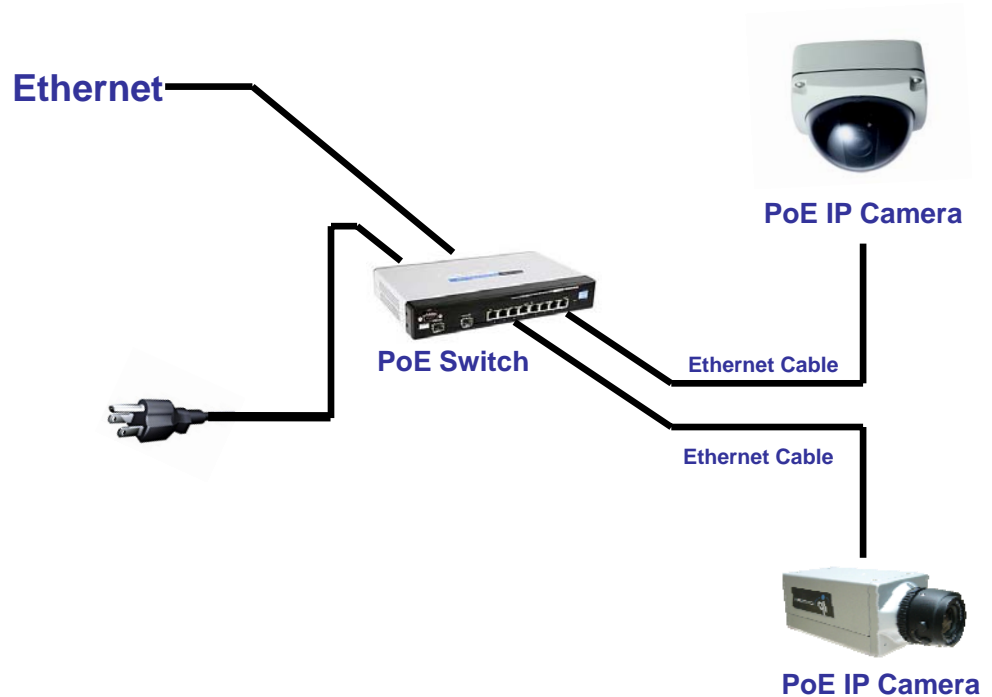

v.

c. IP Assignment

- i. Use the software, "IP Installer" to assign the IP address of IP CAMERA. The software is in the attached software CD.
- ii. There are two languages for IP installer
 - a. IPInstallerCht.exe : Chinese version
 - b. IPInstallerEng.exe : English version
- iii. There are 3 kinds of IP configuration.
 - a. Fixed IP (Public IP or Virtual IP)
 - b. DHCP (Dynamic IP)
 - c. Dial-up (PPPoE)
- iv. Execute IP Installer
- v. For Windows XP SP2 user, the following message may show. Please click "Unblock".



vi. IP Installer configuration:

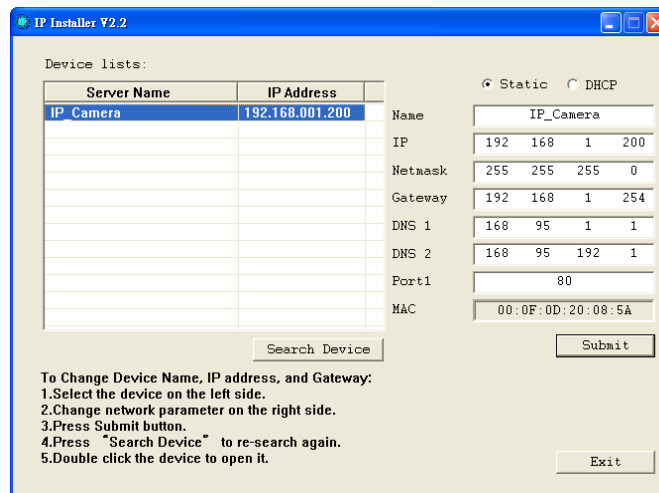

- vii. IP Installer will search all IP Cameras connected on Lan. The user can click “Search Device” to search again.
- viii. Click one of the IP Camera listed on the left side. The network configuration of this IP camera will show on the right side. You may change the “name” of the IP Camera to your preference (eg: Office, warehouse). Change the parameter and click “Submit” then click “OK”. It will apply the change and reboot the Device.

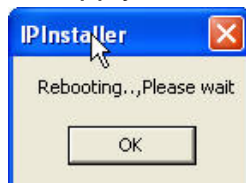

- ix.
- x. Please make sure the subnet of PC IP address and IP CAM IP address are the same.

The same Subnet:

IP CAM IP address: 192.168.1.200

PC IP address: 192.168.1.100

Different Subnets:

IP CAM IP address: 192.168.2.200

PC IP address: 192.168.1.100

To Change PC IP address:

Control Panel→Network Connections→Local Area Connection Properties→Internet Protocol (TCP/IP) →Properties

Please make sure your IP Camera and PC have the same Subnet. If not, please change IP Camera subnet or PC IP subnet accordingly.

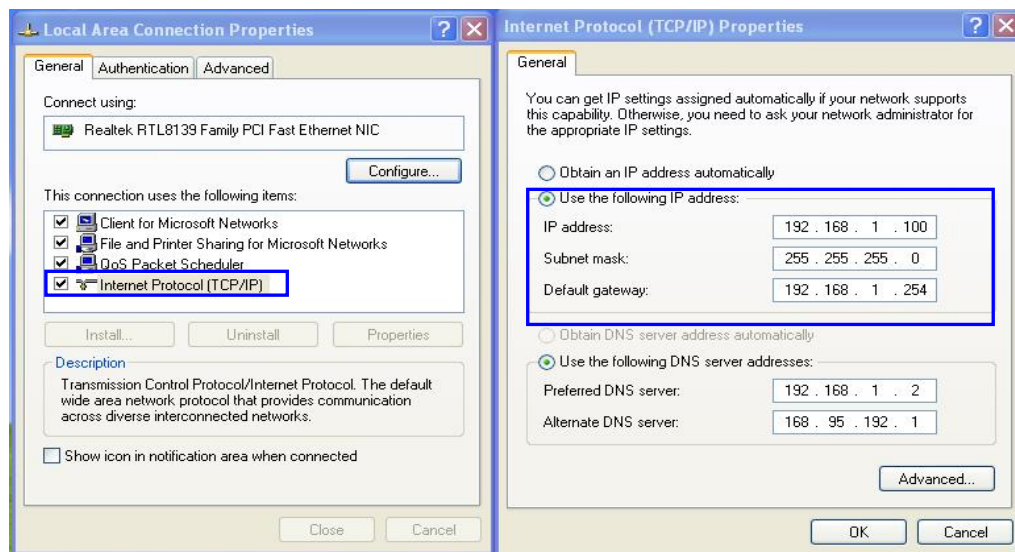

- xi. A quick way to access remote monitoring is to left-click the mouse twice on a selected IP Camera listed on “Device list” of IP Installer. An IE browser will be opened.

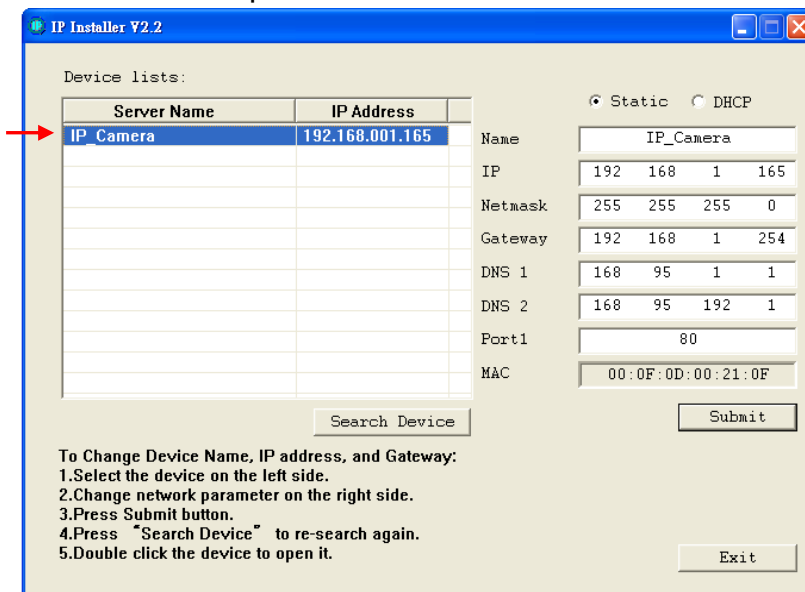

- xii. Then, please key in the default “user name: admin” and “password: admin”.

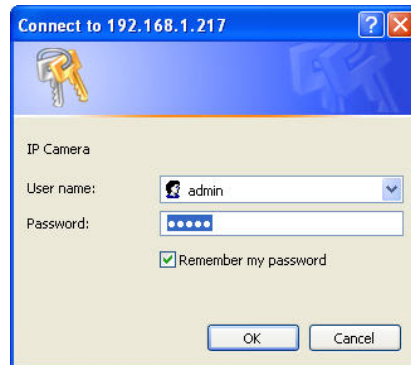

d. Install ActiveX control:

For the first time to view the camera video via IE, it will ask you to install the ActiveX component.

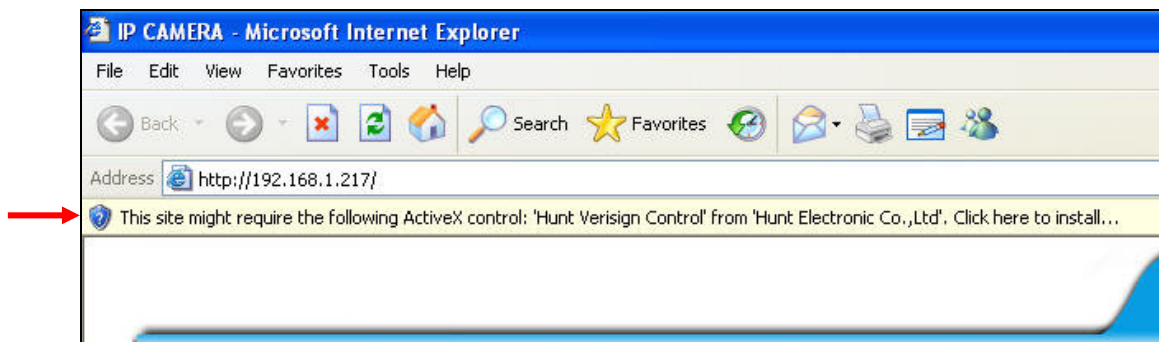

If the installation failed, please check the security setting for the IE browser.

- i. IE → Tools → Internet Options... → Security Tab → Custom Level... → Security Settings → Download unsigned ActiveX controls → Select “Enable” or Prompt.
- ii. IE → Tools → Internet Options... → Security Tab → Custom Level... → Initialize and script ActiveX controls not marked as safe → Select “Enable” or Prompt.

1

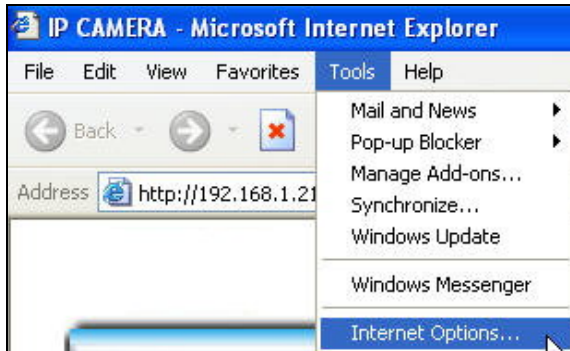

2

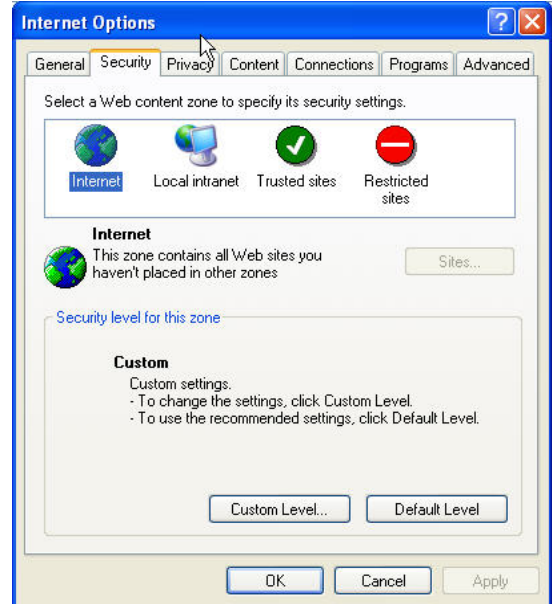

3

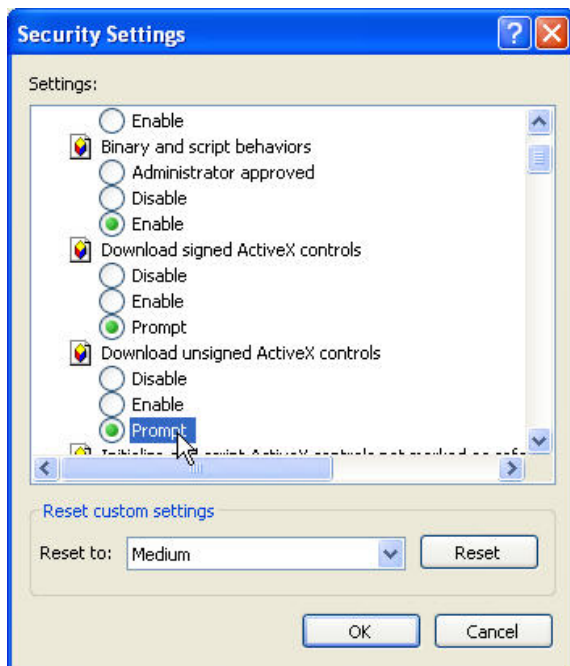

4

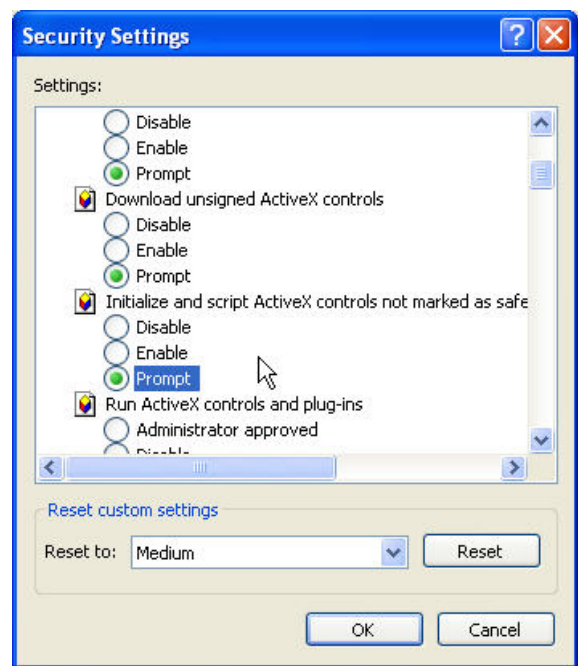

5

When popup the following dialogue box, click "Yes".

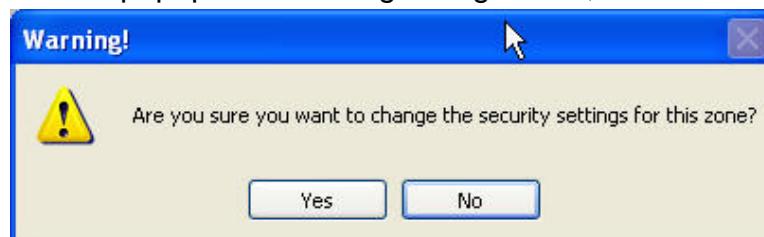

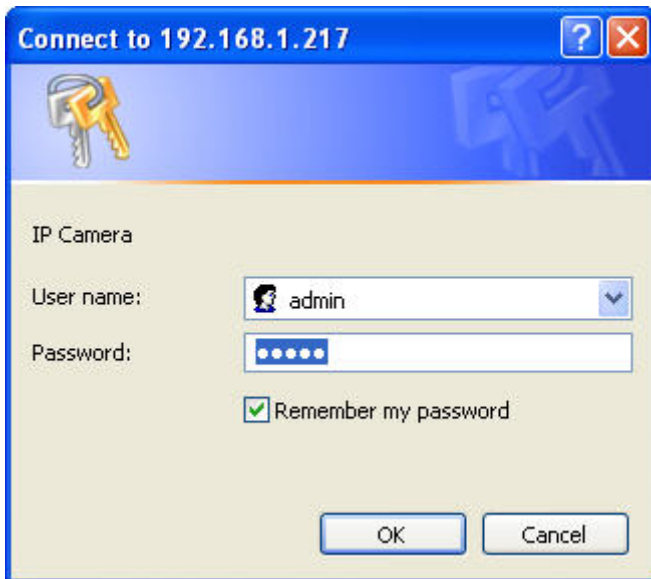

IV. Live Video

Start a IE browser, type the IP address of the IP camera in the address field. It will show the following dialogue box. Key-in the user name and password. The default user name and password are “**admin**” and “**admin**”.

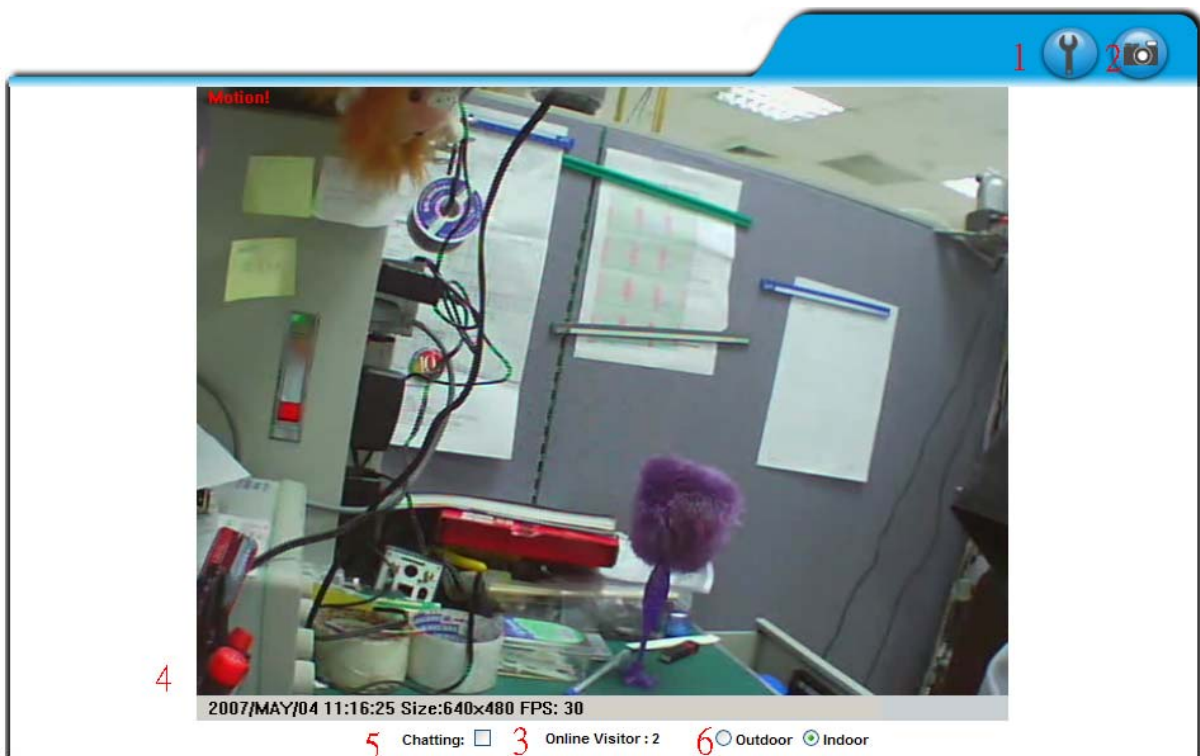

When connect to the IP CAMERA ◦ The following program interface shows.



1.  : Get into the administration page
2.  : Video Snapshot
3. Shows how many people connect to this IP camera
4. Show system time, video resolution, and video refreshing rate
5. IP CAMERA supports 2-way audio. Click the “Chatting” check box. Then you can use microphone which connect to the PC to talk to server side, which is IP CAMERA side.
6. Select Indoor or Outdoor mode.



Double-click the video, it will change to full screen mode. Press “Esc” or double-click the video again, it will change back to normal mode.

Right-Click the mouse on the video, it will show a pop-up menu.



1. Snapshot : Save a JPEG picture
2. Record Start : Record the video in the local PC. It will ask you where to save the video. To stop recording, right-click the mouse again. Select “Record Stop”. The video format is AVI. Use Microsoft Media Player to play the recorded file.
3. Mute : Turn of the audio. Click again to turn on it.
4. Full Screen : Full-screen mode.

V. IP CAMERA Configuration

Click  to get into the administration page. Click  to back to the live video page.



The screenshot displays the configuration web interface for an IP camera. On the left is a dark sidebar menu with icons and labels for various settings: System (gears), Network (globe), AV Setting (film strip and speaker), and Event List (document). The main content area is titled "System Information" and is divided into two sections: "Server Information" and "Time Setting".

System Information

Server Information

Server Name:
MAC Address:
Language: English 繁體中文 简体中文

Time Setting

Server Time: 2007/5/4 16:49:28 Time Zone: GMT+08:00
Date Format: yy/mm/dd mm/dd/yy dd/mm/yy
Time zone:
 NTP :
NTP Server :
 Synchronize with PC's time
Date :
Time :
 Manual
Date :
Time :
 The date and time remain the same

A. System

i. System Information

- a. Server Information: Set up the camera name, select language, and set up the camera time.
 1. Server Name : This is the Camera name. This name will show on the IP Installer.
 2. Select language : There are English, Traditional Chinese, and Simple Chinese to select. When change, it will show the following dialogue box for the confirmation of changing language.



- b. Server time setting : Select options to set up time - "NTP", "Synchronize with PC's time", "Manual", "The date and time remain the same".

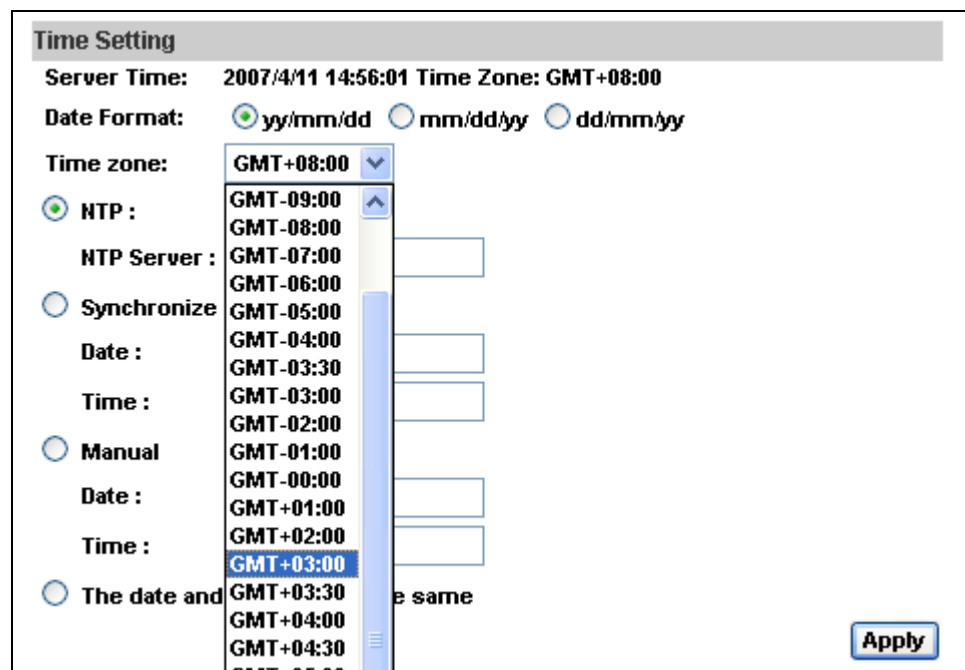

ii · User Management

IP CAMERA supports three different users, administrator, general user, and anonymous user.

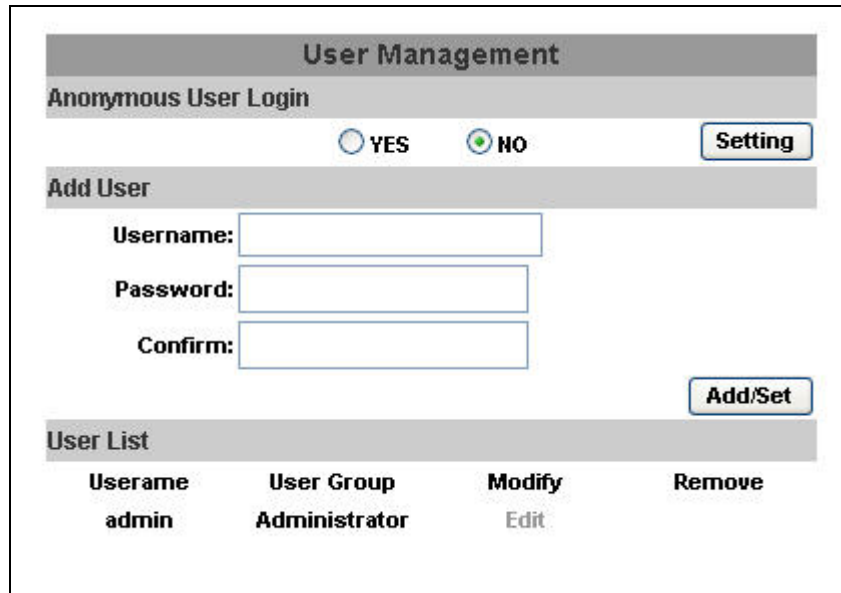

The screenshot shows the 'User Management' web interface. It has a title bar 'User Management' and a section 'Anonymous User Login' with radio buttons for 'YES' and 'NO' (selected), and a 'Setting' button. Below is the 'Add User' section with input fields for 'Username:', 'Password:', and 'Confirm:', and an 'Add/Set' button. At the bottom is the 'User List' section with a table:

Username	User Group	Modify	Remove
admin	Administrator	Edit	

- Anonymous User Login :
Yes : Allow anonymous login
No : Need user name & password to access this IP camera
- Add user :
Type the user name and password, then click "Add/Set".
Note: Allow guest to login as a Guest. Guest is only allowed to browse the page
- Click "edit" or "delete" to modify the user.



The screenshot shows a 'User Setup' dialog box in a Microsoft Internet Explorer window. It has input fields for 'Username:' (containing 'admin'), 'Password:', and 'Confirm:', and an 'OK' button.

iii、System update：

System Update	
Firmware Upgrade	
Firmware Version:	V3.2.20
New Firmware:	<input type="text"/> 浏览...
<input type="button" value="Upgrade"/>	
Reboot System	
<input type="button" value="Start"/>	
Factory Default	
<input type="button" value="Start"/>	
Setting Management	
Save As a File:	Right click the mouse button on Setting Download and then select Save As to save current system's setting in the PC.
New Setting File:	<input type="text"/> 浏览...
<input type="button" value="Upgrade"/>	

- a. To update the firmware online, click “Browse...” to select the firmware. Then click “Upgrade” to the procedure.
- b. Reboot system：re-start the IP camera
- c. Factory default：delete all the settings in this IP camera.
- d. Setting Management：User may download the current setting to PC, or upgrade from previous saved setting.
 1. Setting download:
Right-click the mouse button on Setting Download → Select “Save AS...” to save current IP CAM setting in PC → Select saving directory → Save
 2. Upgrade from previous setting
Browse → search previous setting → open → upgrade → Setting update confirm → click **index.html**. to return to main page

B.Network

i. IP Setting

IP CAMERA supports DHCP and static IP.

IP Setting	
IP Assignment	
<input type="radio"/> DHCP	
<input checked="" type="radio"/> Static	
IP Address:	<input type="text" value="192.168.1.200"/>
Subnet Mask:	<input type="text" value="255.255.255.0"/>
Gateway:	<input type="text" value="192.168.1.254"/>
DNS 0:	<input type="text" value="168.95.1.1"/>
DNS 1:	<input type="text" value="168.95.192.1"/>
Port Assignment	
Web Page Port:	<input type="text" value="80"/>
RTSP Port :	<input type="text" value="554"/>
RTP Start Port:	<input type="text" value="5000"/> [1024..10000]
RTP End port:	<input type="text" value="9000"/> [1025..10000]
UPnP	
UPnP:	<input checked="" type="radio"/> Enabled <input type="radio"/> Disabled
<input type="button" value="Apply"/>	

- a. DHCP : Using DHCP, IP CAMERA will get all the network parameters automatically.
- b. Static IP : Please type in IP address, subnet mask, gateway, and DNS manually.
- c. Port Assignment: user may need to assign different port to avoid conflict when setting up IP assignment.
 1. Web Page Port: setup web page connecting port and video transmitting port (Default: 80)
 2. RTSP Port: setup port for RTSP transmitting (Default: 554)
 3. RTP Start and End Port: in RTSP mode, you may use TCP and UDP for connecting. TCP connection uses RTSP Port (554). UDP connection uses RTP Start and End Port.

d. UPnP

This IP camera supports UPnP, If this service is enabled on your computer, the camera will automatically be detected and a new icon will be added to “My Network Places.”

Note: UPnP must be enabled on your computer.

Please follow the procedure to activate UPnP

1. open the Control Panel from the Start Menu
2. select Add/Remove Programs
3. Select Add/Remove Windows Components and open Networking Services section
4. Click Details and select UPnP to setup the service
5. The IP device icon will be added to “MY Network Places”
6. User may double click the IP device icon to access IE browser

ii \ PPPoE :

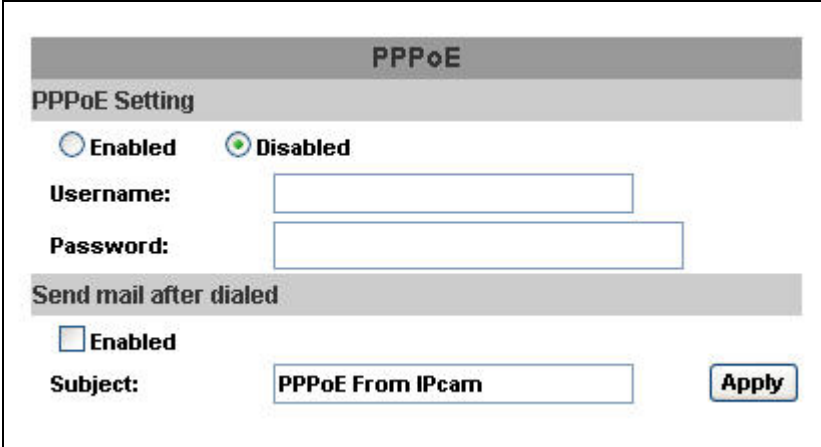

PPPoE

PPPoE Setting

Enabled Disabled

Username:

Password:

Send mail after dialed

Enabled

Subject:

Select “Enabled” to use PPPoE.

Key-in Username and password for the ADSL connection.

Send mail after dialed : When connect to the internet, it will send a mail to a specific mail account. For the mail setting, please refer to “Mail and FTP” settings.

iii 、 DDNS :

IP CAMERA supports DDNS (Dynamic DNS) service.

a. DynDNS :

DDNS

DDNS Setting

Enabled Disabled

Provider: ▼

Hostname:

Username:

Password:

Schedule Update: **Minutes**

State

Idle

Note:

1. **Schedule Update:** Feature of DDNS schedule update is designed for IP products which installed behind the ICS or NAT devices. Update range from every 5 (minutes) to 5000 (minutes) and 0 remain to off.
2. Please note that the hostname will be blocked by DynDNS.org if schedule update is more than once every 5 minutes to 60 minutes. In general, schedule update in every 1440 minutes is recommended.

1. Enable this service
2. Key-in the DynDNS server name, user name, and password.
3. Set up the IP Schedule update refreshing rate.
4. Click “Apply”
5. If setting up IP schedule update too frequently, the IP may be blocked. In general, schedule update every day (1440 minutes) is recommended.

b. Camddns service :

DDNS

DDNS Setting

Enabled Disabled

Provider: ▼

Username:

Schedule Update: Minutes

State

Idle

Note:

1. **Schedule Update:** Feature of DDNS schedule update is designed for IP products which installed behind the ICS or NAT devices. Update range from every 5 (minutes) to 5000 (minutes) and 0 remain to off.
2. Please note that the hostname will be blocked by DynDNS.org if schedule update is more than once every 5 minutes to 60 minutes. In general, schedule update in every 1440 minutes is recommended.

1. Key-in user name.
2. Click "Apply".

c. DDNS Status

1. Updating : Information update
2. Idle : Stop service
3. DDNS registration successful, can now log by
<http://<username>.ddns.camddns.com> : Register successfully.
4. Update Failed, the name is already registered : The user name has already been used. Please change it.
5. Update Failed, please check your internet connection : Network connection failed.
6. Update Failed, please check the account information you provide : The server, user name, and password may be wrong.

i. Wireless Setting (Wireless Network Optional)

Supports 802.11 b/g wireless connection.

Notice : Wireless network and Ethernet network use the same IP, the user has to unplug Ethernet cable, if Ethernet cable is not unplug, wireless setting can not be executed.

Wireless Setting			
Status of Wireless Networks			
SSID	Mode	Security	Signal strength
allan	Infrastructure	WPA	79
RHOSON	Infrastructure	WEP	16
Link	Infrastructure	OFF	16
SinoStar	Infrastructure	WEP	11
7f-2	Infrastructure	WEP	12
00160159A7FA	Infrastructure	WEP	56
RDTEST	Infrastructure	WEP	48
3Com	Infrastructure	OFF	43
Default	Infrastructure	WPA	74

Wireless Setting	
MAC Address:	00:16:16:16:DD:E1
Mode:	Infrastructure
Operation Mode:	Auto
SSID:	allan
Security:	None
<input type="button" value="Apply"/>	

a. Status of Wireless Networks :

it can scan all wireless services.

b. Wireless Setting :

1. **Mode** : There are Infrastructure and Ad-hoc. Infrastructure is for connecting with the router. Ad-hoc is for connecting with PC. There is "Channel" to select only when user uses Ad-hoc mode.

e.g. If one PC's channel is 1, the other's channel has to be 1, too.

Wireless Setting	
MAC Address:	00:11:E2:03:37:48
Mode:	Ad-hoc
Operation Mode:	Auto
SSID:	Default
Channel:	6
Security:	None

2. **SSID** : Based on AP setting.
3. **Channel** : This is used only when the user selects Ad-hoc mode in order to avoid conflict.
4. **Security** : It supports “None”, “WEP”, “WPA-PSK” security encryption based on the setting of the Router.
5. **WEP**:

Security:	WEP
WEP Setting	
Authentication:	Open System
Encryption:	64 bit
Key Type:	HEX (10 character max)
Key 1:	<input checked="" type="radio"/> <input type="text"/>
Key 2:	<input type="radio"/> <input type="text"/>
Key 3:	<input type="radio"/> <input type="text"/>
Key 4:	<input type="radio"/> <input type="text"/>

- Authentication : There are Open System and Shared Keys, it is based on different encryptions. This has to be the same as the Router’s setting.
 - Encryption : There are 64 bits and 128 bits. This is based on Key Type based on the Router’s setting.
 - Key Type : There are HEX and ASCII. When selecting HEX, the user only can input 0~9 characters and use A, B, C, D, E, and F.
 - When selecting ASCII, the user can input any character.
(Case sensitive)
 - Key 1~4 : Based on Key Type to input characters.
6. **WPA-PSK** :

Security:	WPA-PSK
WPA-PSK Setting	
Encryption	TKIP
Pre-Shared Key:	<input type="text"/> (ASCII format, 8-63)

- Encryption : There are TKIP and AES.
- Pre-Shared Key : Allow any characters.(Case sensitive)

C.A/V Setting

i> Image Setting

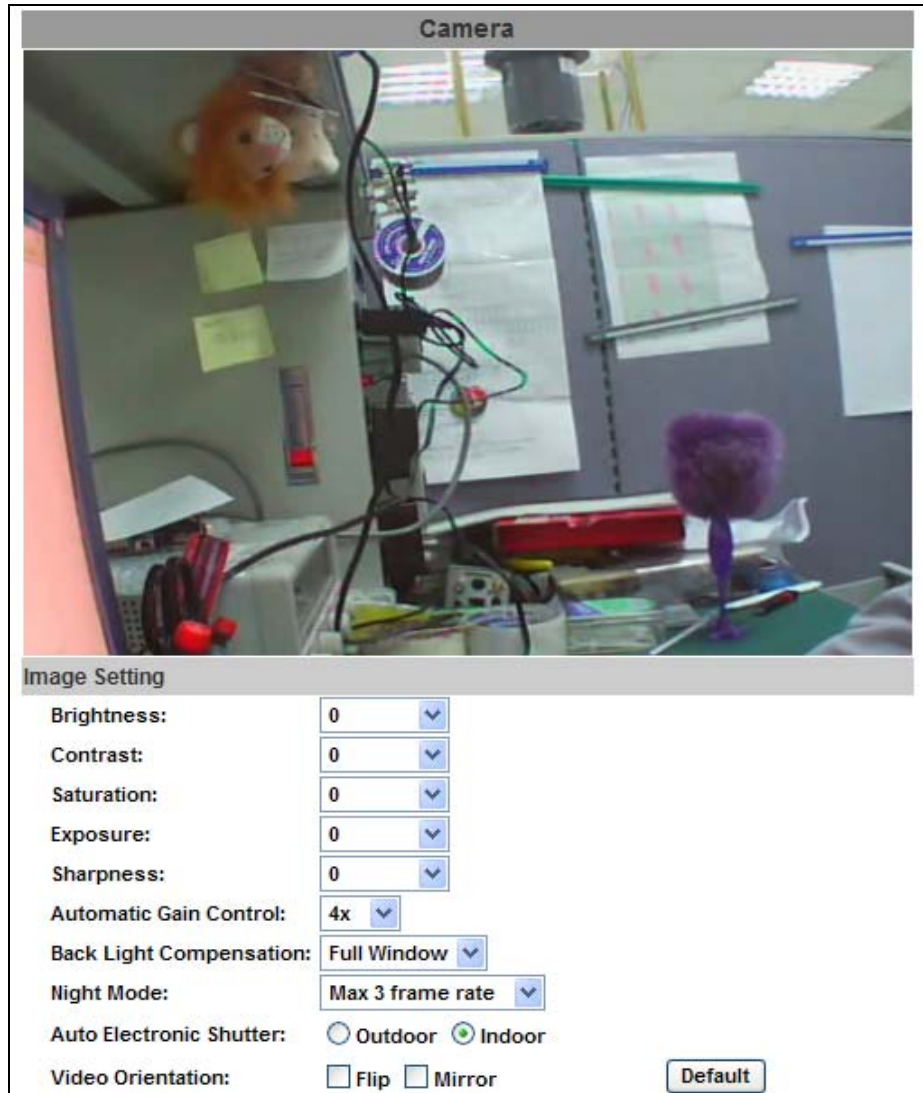

Adjust “Brightness”, “Contrast”, “Hue”, “Saturation”, “Exposure”, “Sharpness”, “Automatic Gain Control”, “Back Light Compensation”, “Night Mode”, “Auto Electronic Shutter” and “Video Orientation” to get clear video.

Night mode:

This function can be set at different Frame rate to increase night illumination. Lower the Frame rate set, slower the frame refresh rate, but better the night illumination.

Night mode will be activated automatically depending on lux illumination, if set at 15 frame rate, when night mode activated at night, the frame rate will not be more than 15FPS

ii · Video Setting

User may select 2 streaming output simultaneously:

Streaming 1 Setting: Basic mode and Advanced mode

Streaming 2 Setting: Basic mode, Advanced mode, and 3GPP mode

(Max Video Frame Rate for both streaming combined is 30 FPS)

a. Streaming 1 Basic Mode :

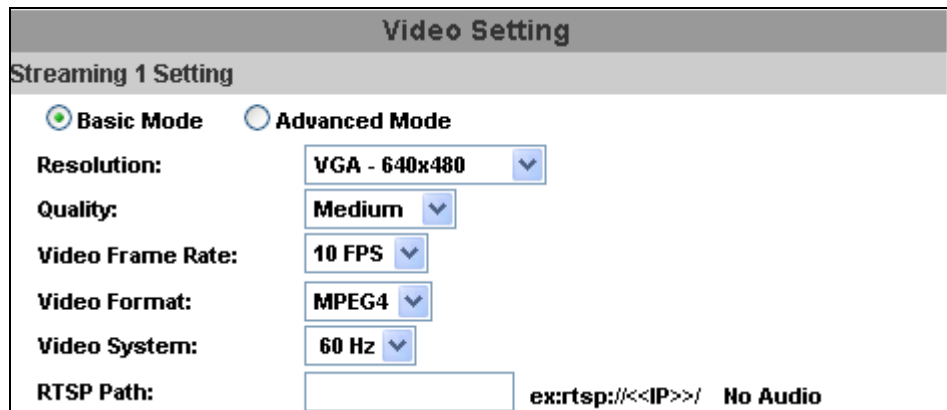

The screenshot shows a web interface titled "Video Setting" with a sub-section "Streaming 1 Setting". It features two radio buttons: "Basic Mode" (selected) and "Advanced Mode". Below are several configuration options, each with a dropdown menu:

- Resolution: VGA - 640x480
- Quality: Medium
- Video Frame Rate: 10 FPS
- Video Format: MPEG4
- Video System: 60 Hz
- RTSP Path: [Empty text box] ex:rtsp://<<IP>>/ No Audio

1. Resolution :

There are 4 resolutions to choose.

VGA – 640×480

QVGA – 320×240

QQVGA – 160×120

2. Quality :

There are 5 levels to adjust. The higher the quality is, the bigger the file size is.

3. Video Frame Rate:

The video refreshing rate per second

4. Video System :

Please select 60 (Hz) if you are in America, Taiwan...

Please select 50 (Hz) if you are in Europe, China...

5. RTSP Path: RTSP output name

b. Streaming 1 Advanced Mode :

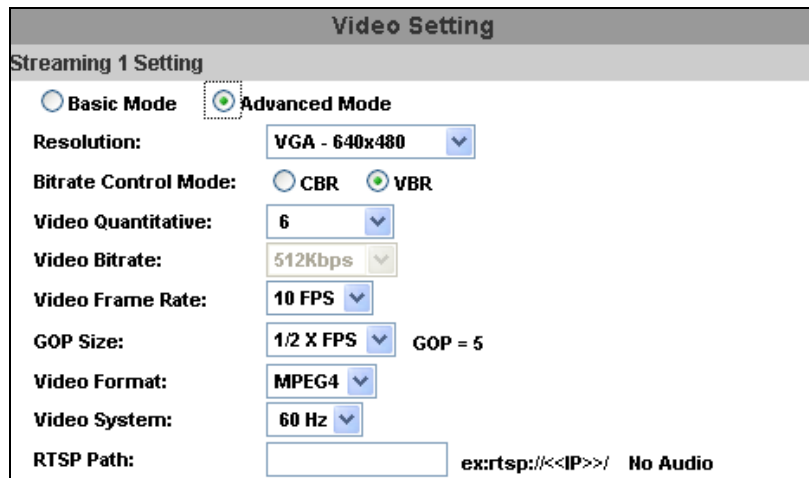

The screenshot shows the 'Video Setting' window for 'Streaming 1 Setting'. It features two radio buttons: 'Basic Mode' (unselected) and 'Advanced Mode' (selected). Below are several configuration options, each with a dropdown menu or radio button:

- Resolution: VGA - 640x480
- Bitrate Control Mode: CBR (unselected) and VBR (selected)
- Video Quantitative: 6
- Video Bitrate: 512Kbps
- Video Frame Rate: 10 FPS
- GOP Size: 1/2 X FPS (with a note 'GOP = 5')
- Video Format: MPEG4
- Video System: 60 Hz
- RTSP Path: A text input field containing 'ex:rtsp://<<IP>>/' followed by 'No Audio'.

1. Resolution :

There are 4 resolutions to choose.

VGA – 640x480

QVGA – 320x240

QQVGA – 160x120

2. Bitrate Control Mode

There are CBR [Constant Bit Rate] and VBR [Variable Bit Rate] to use.

CBR : 32Kbps~4Mbps (the higher the CBR is, the better the video quality is , vice versa)

VBR : 1~10 (Compression Rate)

3. Video Frame Rate

The video refreshing rate per second.

4. GOP Size

It means "Group of Pictures". (The higher the GOP is, the better the quality is, vice versa)

5. Video System :

Please select 60 (Hz) if you are in America, Taiwan...

Please select 50 (Hz) if you are in Europe, China...

6. RTSP Path: RTSP output name

c. Streaming 2 Basic Mode :

Streaming 2 Setting	
<input checked="" type="radio"/> Basic Mode	<input type="radio"/> Advanced Mode
<input type="radio"/> 3GPP Mode	<input type="radio"/> Close
Resolution:	QQVGA - 160x120
Quality:	Low
Video Frame Rate:	20 FPS
Video Format:	MPEG4
RTSP Path:	v2 <code>ex:rtsp://<<IP>>/v2</code> No Audio

1. Resolution :
There are 4 resolutions to choose.
VGA – 640x480
QVGA – 320x240
QQVGA – 160x120
2. Quality :
There are 5 levels to adjust. The higher the quality is, the bigger the file size is.
3. Video Frame Rate:
The video refreshing rate per second
4. RTSP Path: RTSP output name

d. Streaming 2 Advanced Mode :

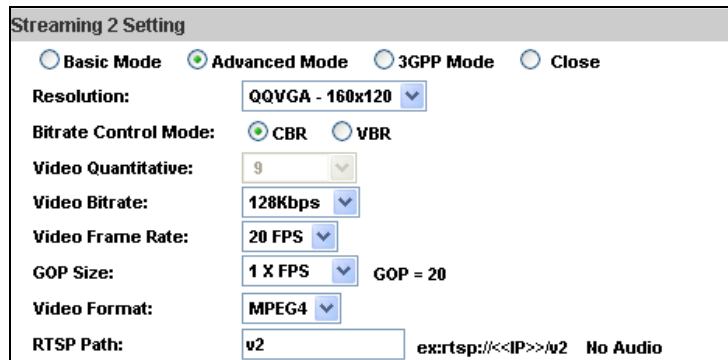

The screenshot shows the 'Streaming 2 Setting' dialog box with the following configuration:

- Mode: Basic Mode, Advanced Mode, 3GPP Mode, Close
- Resolution: QQVGA - 160x120
- Bitrate Control Mode: CBR, VBR
- Video Quantitative: 9
- Video Bitrate: 128Kbps
- Video Frame Rate: 20 FPS
- GOP Size: 1 X FPS, GOP = 20
- Video Format: MPEG4
- RTSP Path: v2, ex:rtsp://<<IP>>/v2 No Audio

1. Resolution :

There are 4 resolutions to choose.

VGA – 640×480

QVGA – 320×240

QQVGA – 160×120

2. Bitrate Control Mode

There are CBR [Constant Bit Rate] and VBR [Variable Bit Rate] to use.

CBR : 32Kbps~4Mbps (the higher the CBR is, the better the video quality is)

VBR : 1~10 (Compression Rate)

3. Video Frame Rate

The video refreshing rate per second.

4. GOP Size

It means "Group of Pictures". The higher the GOP is, the better the quality is.

5. RTSP Path: RTSP output name

e. Streaming 2, 3GPP mode:

Streaming 2 Setting

Basic Mode
 Advanced Mode
 3GPP Mode
 Close

Resolution:

Bitrate Control Mode: CBR VBR

Video Quantitative:

Video Bitrate:

Video Frame Rate:

GOP Size: **GOP = 20**

Video Format:

3GPP Path: **ex:rtsp://<<IP>>/3g Audio:AMR**
ex:rtsp://<<IP>>/3gx No Audio

3GPP default value is QQVGA , 128Kbp , 5FPS , GOP=1XFPS

3GPP mode suggested setting: QQVGA, lower than 128kbps, 5FPS, GOP= 1x FPS or 2x FPS, MPEG4 format

3GPP can achieve up to 10FPS, In 3GPP mode, Stream 1 & Stream 2 combined frame rate is 20FPS

1. Fix Resolution :
QQVGA – 160x120
2. Bitrate Control Mode
There are CBR [Constant Bit Rate] and VBR [Variable Bit Rate] to use.
CBR : 32Kbps~320bps (the higher the CBR is, the better the video quality is)
VBR : 1~10 (Compression Rate)
3. Video Frame Rate (**5 FPS is recommended**)
The video refreshing rate per second.
4. GOP Size
It means "Group of Pictures". The higher the GOP is, the better the quality is.
5. Video Format : MPEG4
6. 3GPP: 3GPP output name

iii 、 Audio :

IP CAMERA supports 2-way audio.

1. Audio from IP Camera built-in mic to local PC, select “Enable” to start this function.

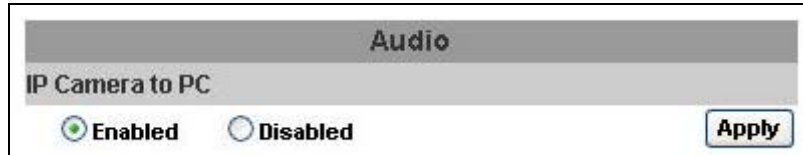

2. Audio from local PC to IP camera, check “chatting” in the browsing page.

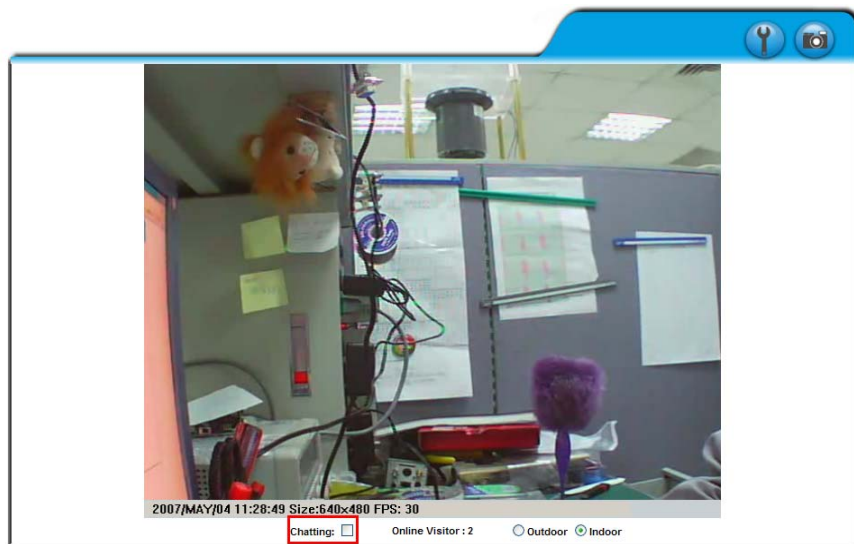

The Audio will not be smooth when enable SD card recording function simultaneously.

D.Event List

IP CAMERA provides multiple event settings.

i. Event Setting

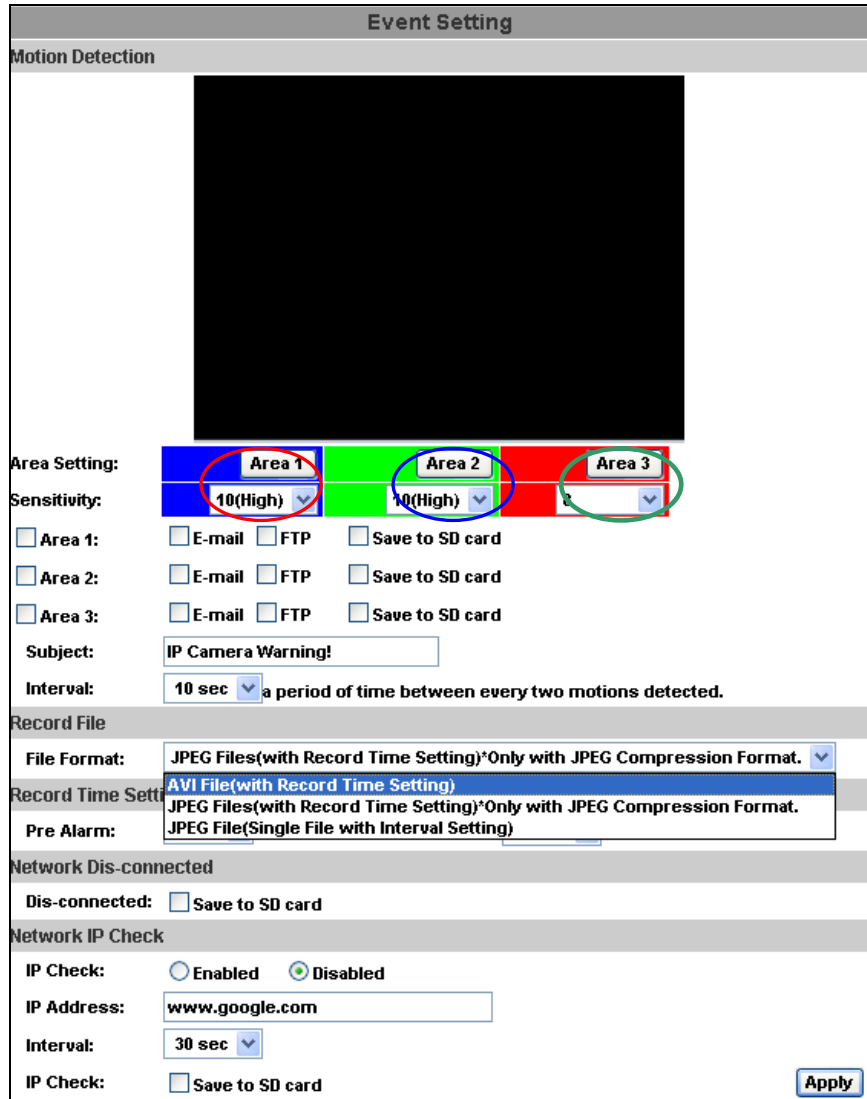

a. Motion Detection

IP CAMERA allows 3 areas motion detection. When motion is triggered, it can send video to some specific mail addresses, transmit video to remote ftp server, trigger the relay, and save video to local SD card. To set up the motion area, click “Area Setting”. Using mouse to drag and set the area. The same operation for area 2 and 3.

b. Record File Setting: IP CAMERA allows 3 different types of recording file to change its record size.

When motion/alarm is triggered, there are 3 different types of record mode.

1. AVI File (With Record File Setting)
 2. Multi-JPEG (With Record File Setting), only with JPEG compression format.
 3. Single JPEG (Single File with Interval Setting)
- c. Record Time Setting : Pre Alarm and Post Alarm setups for video start and end time when motion detected .
Note: Pre/Post Alarm record time is base on record time setting and IP Cam built-in Ram memory. Limited by IP Cam built-in Ram Memory, When information is too much or video quality set too high, it will cause recording frame drop or decrease on post alarm recording time.
- d. Network Dis-connected
When the network is down, it will save the video to local SD card. This function is only enabled in wire connection.
- a. Network IP check
For the use of recording software, IP CAMERA supports the detection of network connection. Whenever the connection is down, it records the video to SD card. To use this function, key in the IP address of the PC which is installed in the recording software, and enable the function of “Save to SD card”, then click “Apply”.
The interval of two video files on SD card is fixed with 30 seconds..
The interval of two video files recorded on SD card is fixed with 30 seconds.

i、 Mail & FTP

To send out the video via mail of ftp, please set up the configuration first.

Mail & FTP	
Mail Setting	
Mail Server:	<input type="text"/>
Username:	<input type="text"/>
Password:	<input type="text"/>
Sender's Mail:	<input type="text"/>
Receiver's Mail:	<input type="text"/>
Bcc Mail:	<input type="text"/>
FTP Setting	
FTP Server:	<input type="text"/>
Username:	<input type="text"/>
Password:	<input type="text"/>
Port:	<input type="text" value="21"/>
Path:	<input type="text" value="/"/>
<input type="button" value="Apply"/>	

ii、 Log List

Log List	
System Logs	Logs
Motion Detection Logs	Logs
I/O Logs	Logs
All Logs	Logs

Sort by System Logs, Motion Detection Logs and I/O Logs. In addition, System Logs and I/O Logs won't lose data due to power failure.

iii、 SD card

Please Insert SD card before use it. Make sure pushing SD card into the slot completely.

Note : The use of the SD card will affect the operation of the IP CAMERA slightly, such as affecting the frame rate of the video.



a. Playback :



1. It will show the capacity of the SD card. Click the date listed on this page. It will show the list of the video.

2006/04/17			Del
Time	Video	Event Type	<input type="checkbox"/>
09:05:22	090522f.avi	Network Dis-connected	<input type="checkbox"/>
09:05:52	090552f.avi	Network Dis-connected	<input type="checkbox"/>
09:06:22	090622f.avi	Network Dis-connected	<input type="checkbox"/>
09:06:52	090652f.avi	Network Dis-connected	<input type="checkbox"/>
09:07:22	090722f.avi	Network Dis-connected	<input type="checkbox"/>
09:07:52	090752f.avi	Network Dis-connected	<input type="checkbox"/>
09:08:22	090822f.avi	Network Dis-connected	<input type="checkbox"/>
09:08:51	090851f.avi	Network Dis-connected	<input type="checkbox"/>
09:09:21	090921f.avi	Network Dis-connected	<input type="checkbox"/>
09:09:51	090951f.avi	Network Dis-connected	<input type="checkbox"/>

1 2 3 4 5

2. The video format is AVI. Click the video to start Microsoft Media Player to play it.
3. To delete the video, check it, then click **Del**. When the SD card is full, it will remove the oldest video automatically.

VI. Network Configuration

i. Configuration 1:

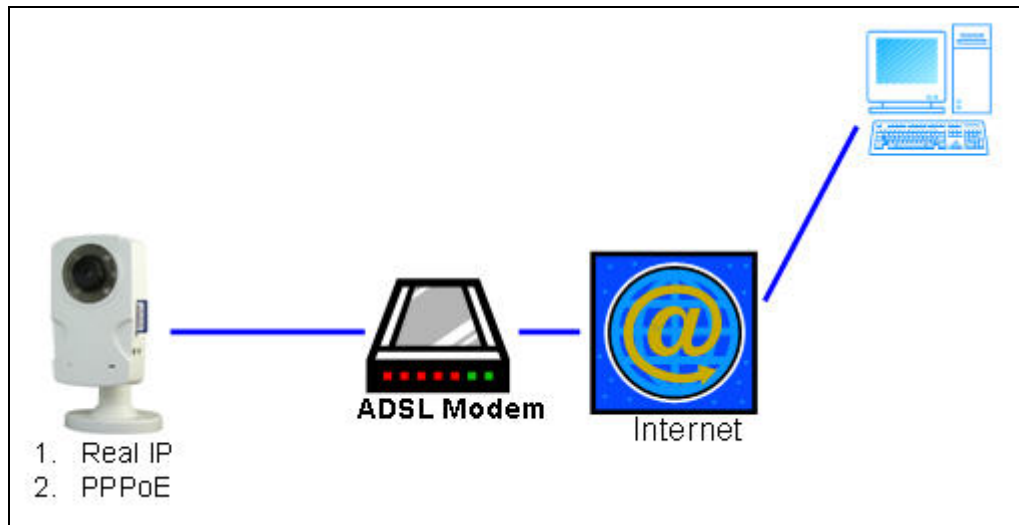

- a. Internet Access : ADSL or Cable Modem
- b. IP address : One real IP or one dynamic IP
- c. Only IP CAMERA connects to the internet
- d. For fixed real IP, set up the IP into IP CAMERA. For dynamic IP, start PPPoE.

ii 、 Configuration 2:

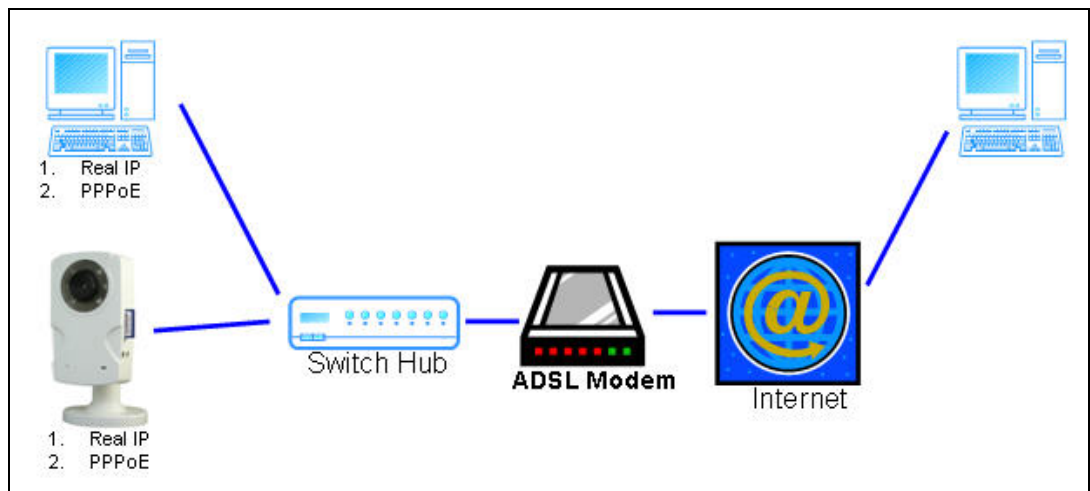

- a. Internet Access : ADSL or Cable Modem
- b. IP address : More than one real IP or one dynamic IP
- c. IP CAMERA and PC connect to the internet
- d. Device needed : Switch Hub
- e. For fixed real IP, set up the IP into IP CAMERA and PC. For dynamic IP, start PPPoE.

iii 、 Configuration 3:

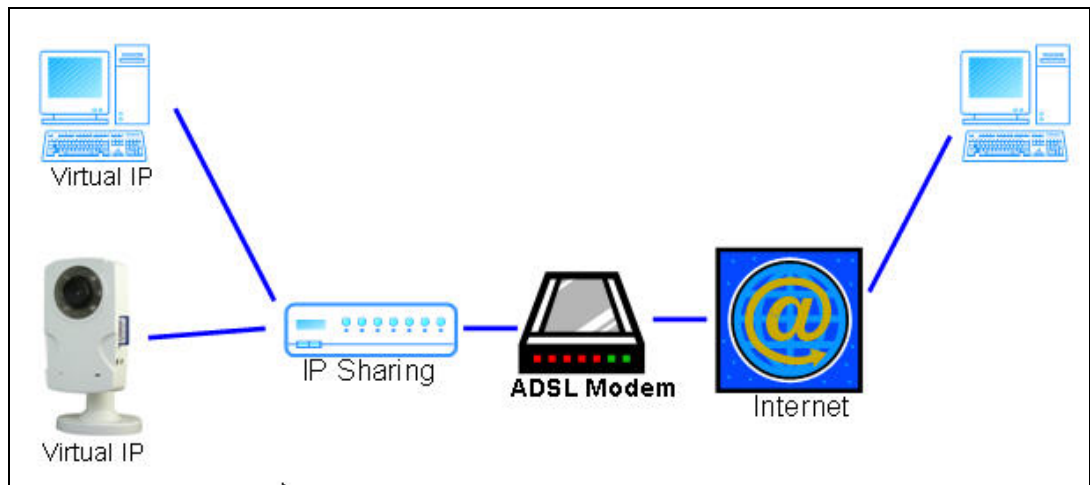

- a. Internet Access : ADSL or Cable Modem
- b. IP address : one real IP or one dynamic IP
- c. IP CAMERA and PC connect to the internet
- d. Device needed : IP sharing
- e. Use virtual IP, set up port forwarding in IP sharing.

VII. Factory Default

- i \ To recover the default IP address and password, please follow the following steps.
- ii \ Remove power, and press and hold the button in the back of IP CAMERA.



- iii \ Power on the camera. Don't release the button during the system booting.
- iv \ It will take around 30 seconds to boot the camera.
- v \ Release the button when camera finishes proceed.
- vi \ Re-login the camera using the default IP (<http://192.168.1.200>), and user name (admin), password (admin).

VIII. Package contents

- i \ IP CAMERA Network Camera
- ii \ Adaptor
- iii \ Ethernet Cable
- iv \ CD title (User manual, IP installation Utility)

Appendix I

SD Card Recommended :

SanDisk 128M	Transcend 128M 80X
SanDisk 256M	Transcend 256M 80X
SanDisk 512M	Transcend 512M 80X
SanDisk 1G	Transcend 1G 80X
SanDisk 2G	Transcend 2G 80X
SanDisk 4G	Transcend 4G 80X