

USER MANUAL

16 CHANNELS

DIGITAL VIDEO RECORDER

INSTRUCTION MANUAL

To obtain the best performance and ensure device function correctly, please read this instruction manual carefully and completely.

FCC Compliance

USER-INSTALLER CAUTION: YOUR AUTHORITY TO OPERATE THIS FCC VERIFIED EQUIPMENT COULD BE VOIDED IF YOU MAKE CHANGES OR MODIFICATIONS NOT EXPRESSLY APPROVED BY THE PARTY RESPONSIBLE FOR COMPLIANCE TO PART 15 OF THE FCC RULES.

NOTE: THIS EQUIPMENT HAS BEEN TESTED AND FOUND TO COMPLY WITH THE LIMITS FOR A CLASS A DIGITAL DEVICE, PURSUANT TO PART 15 OF THE FCC RULES. THESE LIMITS ARE DESIGNED TO PROVIDE REASONABLE PROTECTION AGAINST HARMFUL INTERFERENCE WHEN THE EQUIPMENT IS OPERATED IN A COMMERCIAL ENVIRONMENT. THIS EQUIPMENT GENERATES, USES, AND CAN RADIATE RADIO FREQUENCY ENERGY AND IF NOT INSTALLED AND USED IN ACCORDANCE WITH THE INSTRUCTION MANUAL, MAY CAUSE HARMFUL INTERFERENCE TO RADIO COMMUNICATIONS.

OPERATION OF THIS EQUIPMENT IN A RESIDENTIAL AREA IS LIKELY TO CAUSE HARMFUL INTERFERENCE IN WHICH CASE THE USER WILL BE REQUIRED TO CORRECT THE INTERFERENCE AT HIS OWN EXPENSE.



THIS CLASS A DIGITAL APPARATUS MEETS ALL REQUIREMENTS OF THE CANADIAN INTERFERENCE-CAUSING EQUIPMENT REGULATIONS.

WARNINGS, CAUTIONS & COPYRIGHT



WARNINGS

TO REDUCE THE RISK OF FIRE OR ELECTRIC SHOCK, DO NOT EXPOSE THIS PRODUCT TO RAIN OR MISTURE.
DO NOT INSERT ANY METALLIC OBJECT THROUGH VENTILATION GRILLS.

CAUTION

	CAUTION RISK OF ELECTRIC SHOCK DO NOT OPEN	
<p>CAUTION: TO REDUCE THE RISK OF ELECTRIC SHOCK. DO NOT REMOVE COVER (OR BACK). NO USER-SERVICEABLE PARTS INSIDE. REFER SERVICING TO QUALIFIED SERVICE PERSONNEL.</p>		

Explanation of Graphical Symbols

	The lightning flash with arrowhead symbol, within an equilateral triangle, is intended to alert the user to the presence of insinuated "dangerous voltage" within the products enclosure that may be of sufficient magnitude to constitute a risk of electric shock to persons.
	The exclamation point within an equilateral rhombus is intended to alert the user to the presence of important operating and maintenance (servicing) instruction in the literature accompanying the product.

USERS OF THE SYSTEM ARE RESPONSIBLE FOR CHECKING AND COMPLYING WITH ALL FEDERAL, STATE, AND LOCAL LAWS AND STATUTES COIPCERNING THE MONITORING AND RECORDING OF VIDEO AND AUDIO SIGNALS. ULTRAK SHALL NOT BE HELD RESPONSIBLE FOR THE USE OF THIS SYSTEM IN VIOLATION OF CURRENT LAWS AND STATUTES.

COPYRIGHT

THE TRADEMARKS MENTIONED IN THE MANUAL ARE LEGALLY REGISTERED TO THEIR RESPECTIVE COMPANIES.

TABLE OF CONTENTS

1	INTRODUCTION	5
1.1	FEATURE.....	5
1.2	SPECIFICATION.....	5
2	HARDWARE OVERVIEW	8
2.1	FRONT PANEL.....	8
2.2	BACK PANEL.....	9
2.3	ADVANCED AUTO SWITCH, ZOOM, PTZ, COPY KEY CONTROL & USB INFORMATION.....	9
2.4	EXTERAL ALARM.....	10
2.5	IR REMOTE CONTROL.....	12
2.6	PTZ (PAN, TILT AND ZOOM) CAMERA.....	13
3	SYSTEM SETUP	14
3.1	MENU SETUP INTERFACE(GUI).....	14
3.2	LIVE VIEWING AND POP-UP MENU.....	16
3.3	CAMERA SETUP.....	19
3.4	AUTHORITY.....	22
3.5	NETWORK SETUP.....	23
3.6	SYSTEM SETUP.....	27
3.7	RECORD SETUP.....	30
3.8	HDD MANAGEMENT.....	32
3.9	ALARM SETUP.....	33
4	DVR PLAYBACK	35
4.1	TIME SEARCH.....	36
4.2	EVENT SEARCH.....	36
4.3	BACKUP.....	37
4.4	SYSTEM LOG.....	38
5	BACKUP PLAYBACK	39
5.1	MAIN SCREEN SETTING.....	39
5.2	USB & LOCAL BACKUP FILE PLAYBACK.....	43
5.3	BACKUP FILE TO AVI.....	45
6	NETWORK VIEWING & PLAYBACK	46
6.1	IP ADDRESS SETUP ON PC SITE.....	46
6.2	OPTIONAL MICROSOFT INTERNET EXPLORER SETUP.....	47
6.3	LOGIN.....	50
6.4	REMOTE CONTROL.....	51
6.5	CONFIGURE.....	56
	APPENDIX A: RECORDING TIME LAPSE (HOURS)	64
	FULL D1-720 x 480	64

Half D1- 720x240 66
CIF-360x240 68
APPENDIX B: HDD COMPATIBLE TABLE 70
APPENDIX C: ERROR MESSAGE LIST..... 71

1 INTRODUCTION

1.1 FEATURE

- H.264 hardware video compression
- Recording rate up to 240 PPS @ D1 (NTSC)
- Support CMS (Central Management System)
- Powerful mobile surveillance function, support JAVA 、blackberry 、i-Phone & Windows mobile
- Audio : 4 in & 1out/ Audio Backup / Audio Streaming.
- Individual recording setup & function for each channel
- Support Privacy Mask
- HDD damaged block detection & temperature alarm system (HDD S.M.A.R.T)
- Support Water Mark
- Support Pre-alarm
- Playback Preview Function. The user can search the desired recording data easily
- DVR log function (ex. user login/ logout) for device safety management
- Up to four online clients for independent remote control; individual live-time, play-back & time-search function available

1.2 SPECIFICATION

VIDEO		
MODE	Multiplex	
IMAGE SYSTEM	NTSC	PAL
LIVE-TIME RESOLUTION	720x480	720x576
LIVE-TIME DISPLAY RATE	16 x 30 Frame / Sec	16 x 25 Frame / Sec
SPLIT SCREEN	1,4 ,9 ,16	
VIDEO INPUT	BNC x 16	
VIDEO OUTPUT (BNC)	BNC x 1	
VIDEO OUTPUT (SPOT MONITOR)	BNC x 1	
VIDEO OUPUT (HDMI)	Yes (optional)	
VIDEO OUTPUT (VGA)	Yes	
AUDIO		
AUDIO INPUT	RCA x 4	
AUDIO OUTPUT	RCA x 1	
AUDIO BACKUP	Yes	
AUDIO STREAMING	Yes	
RECORDING		
COMPRESSION TYPE	H.264	

RECORDING RESOLUTION (D1)	720x480	720x576
RECORDING RESOLUTION (HALF D1)	720x240	720x288
RECORDING RESOLUTION (CIF)	360x240	360x288
RECORDING RATE (D1)	720 x 480 up to 240 PPS	720 x 576 up to 200 PPS
RECORDING RATE (HALF D1)	720 x 240 up to 480 PPS	720 x 288 up to 400 PPS
RECORDING RATE (CIF)	360 x 240 up to 480 PPS	360 x 288 up to 400 PPS
RECORDING MODE	Manual / Schedule / Alarm	
PLAYBACK & SEARCH		
PLAYBACK SPEED	Fast Forward X 2 X 8 X 16 X32 X64 Fast Backward X 2 X 4 X 8 Frame by Frame Playback Pause	
TIME SEARCH	Yes	
EVENT SEARCH	Yes	
EVENT LIST	10000 records per H.D.D (Maximum)	
OSD & CONTROL INTERFACE		
TITLE	8 Characters	
ON SCREEN DISPLAY & SETUP	Time / Date / Setup Menu	
GRAPHIC USER INTERFACE (GUI)	Yes	
DVR CONTROL PANEL	Yes	
MOUSE	Yes	
IR REMOTE CONTROLLER	Yes	
IE BROWSER	Yes	
PLAYER	Yes	
STORAGE & BACKUP DEVICE		
INTERNAL HDD SUPPORT	SATA HDD x 2 (optional HDD x 4)	
EXTERNAL USB BACKUP DEVICE (PAN DRIVE, HDD, BURNER)	Yes	
INTERNAL DVD BURNER BACKUP	No	
NETWORK		
ETHERNET	Yes	
ETHERNET COMPRESSION FORMAT	H.264	
IE REMOTE CONTROL	Yes	
DDNS	Yes	
NTP	Yes	
E-MAIL & FTP	Yes	
NETWORK IP	Static/ Dynamic/ PPPoE	

MULTI-REMOTE CLIENT	Yes (4 Clients at the same time available)
PDA/ CELL PHONE SUPPORT	Yes
ALARM	
ALARM INPUT	8 In
ALARM OUTPUT	2 Out (NO/ NC)
MOTION DETECTION	Yes
MOTION DETECTION AREA	8 x 8 grids
MOTION DETECTION SENSITIVITY	1-10
VIDEO LOSS DETECTION	Yes
ALARM RECORDING	Yes
PRE-ALARM RECORDING	Yes
BUZZER	Yes
SETUP & OTHER FUNCTIONS	
DAYLIGHT SAVING TIME	Yes
WATER MARK	Yes
PRIVACY MASK	Yes
PTZ CONTROL	Yes
RS-485	Yes
DIGITAL ZOOM	Yes
PASSWORD CONTROL	Two levels, one for system and the other for HDD format
KEY-LOCK	Yes
MULTI-LANGUAGE	Yes
FIRMWARE UPDATE	USB Host & Update on line
OTHERS	
POWER INPUT	DC 12V
DIMENSIONS (W x H x D)	370mm (W) x 60mm (H) x 311mm (D)
OPERATION TEMPERATURE	0 - 45 °C



*** SPECIFICATIONS ARE SUBJECT TO CHANGE WITHOUT NOTICE**

2 HARDWARE OVERVIEW

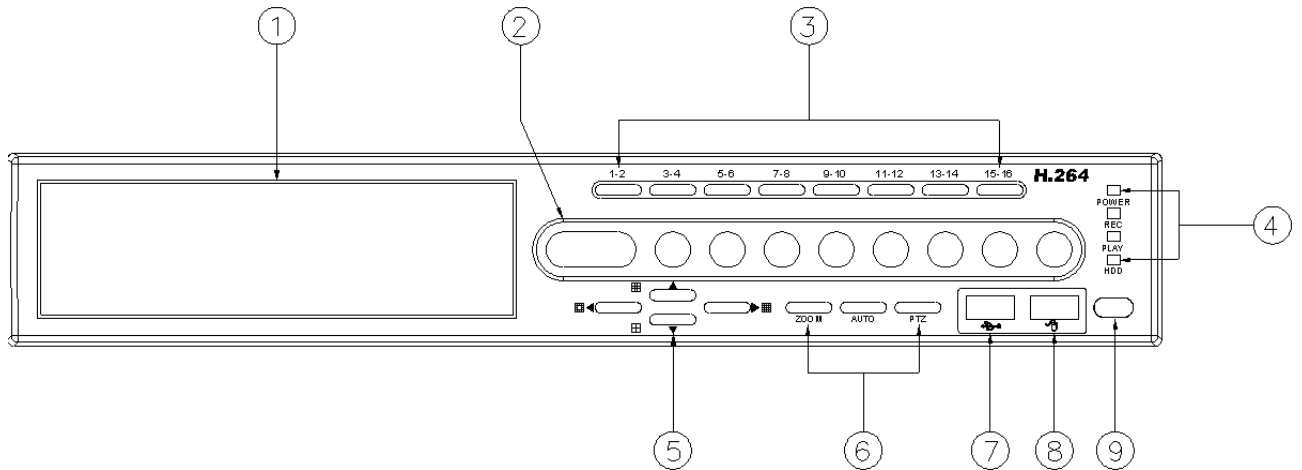
2.1 FRONT PANEL



DVR OPERATION

NO.	LABEL	OPERATION	PTZ
1	DVD RW	Slot For DVD RW.(Reserved)	
2	MENU and other CONTROL Keys	Buttons Of Menu, Enter, Copy, REW, Stop, Pause, FF, Play and Rec.	
3	1-16	Press The Button To Display No.1~No.8 Full Screen	
4	LED	Led Indicator	
5	▲▼◀▶	Button Of Controller. Button Of Switching Channel.	UP, DOWN, LEFT & RIGHT
6	FUNCTION KEYS	Zoom, Auto and PTZ Button.	
7		USB Connector.	
8		USB Mouse Connector (Only by supplied mouse).	
9		IR Sensor For Remote Control.	

2.2 BACK PANEL

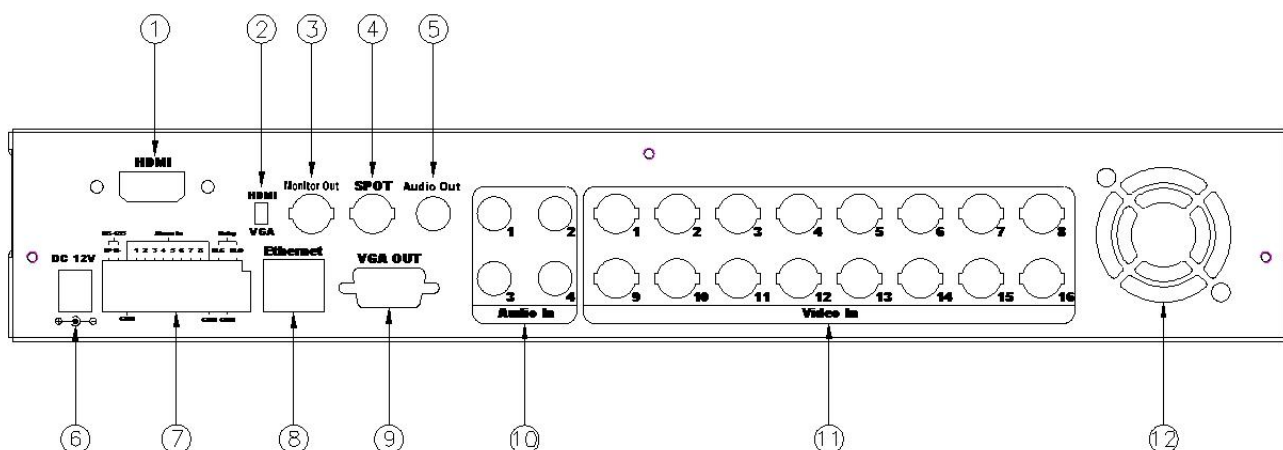

NO.	LABEL	OPERATION
1	VIDEO OUT (HDMI)	HDMI connector (Reserved)
2	HDMI/ VGA	Switch video output in HDMI or VGA
3	MONITOR OUT	Video output with BNC connector.
4	SPOT	SPOT video output.
5	AUDIO OUT	Audio output.
6	POWER	Power switcher: DC 12V/ 5A input
7	RS-485/ ALARM IN/ RELAY OUT	2 pin RS-485/ 8 pin alarm input connector; 2 pin GND connector/ 2 pin Relay connector, 1 pin COM connector
8	ETHERNET	RJ-45 connector for network.
9	VGA D-SUB OUT (VGA)	VGA connector. Connect to CRT or LCD monitor.
10	AUDIO IN	Audio input x 4.
11	VIDEO INPUT	Video input with BNC connector.
12	FAN	Cooling fan.

NOTE: DO NOT REMOVE and PLUG IN the supplied mouse while DVR is operating.

2.3 ADVANCED AUTO SWITCH, ZOOM, PTZ, COPY KEY CONTROL & USB INFORMATION

AUTO SWITCH : In the split screen mode, use the “QUAD+ ►►” keys in the front panel to enable auto switch function. Moreover, press “ ►►” key again to disable it.

ZOOM : In the full screen mode, user can use compound key “ ENTER/ COPY ” on the front panel to perform ZOOM function. Press ▲ ▼ ◀ ▶, located on the front panel, to move the zoom window.

PTZ : When camera supported PTZ function, user can use “ ►► ” button on the front panel to perform PTZ function. Press ▲▼◀► to select and change setup value.

COPY : Within the playback mode, press “ ENTER/ COPY ” button to start backup record and press “ ENTER/ COPY ” again to end backup. The user can see the backup image approx. 3 ~5 sec.

USB INFORMATION: Within the LIVE VIEWING, press “ENTER” key in the front panel will present the USB information. (**NOTE: Please confirm that USB Device has plugged into DVR.**)

2.4 EXTERNAL ALARM

There are three types of alarms that the system can be configured to handle. They are Motion detection Alarm, External Alarm and Video Loss Alarm.

A. Motion detection Alarm and External Alarm:

When motion detection or External Alarm was triggered, there are 5 possible actions will be taken.

- a. Changes recording speed as alarm recording speed.
- b. Monitor will display corresponding full screen alarm channel, it will switch automatic mode to manual mode if buttons pressing activity occurred in 5 seconds.
- c. Relays can be activated by motion detection or external alarm when turning on.
- d. The camera title will be transformed into color of yellow when motion is happening, “ALARM” text will show up when external alarm is triggered.

B. Video Loss Alarm:

The default setting of Video Loss alarm is enabled.

Terminal Connectors:

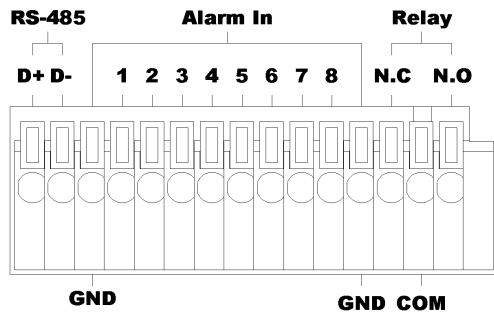

D+	RS-485 sends +/ receives +
D -	RS-485 sends -/ receives -
GND	GND
ALARM IN 1-08	Camera alarm input.
GND	GND
N.C	Relay N.C.
COM	Relay COM
N.O	Relay N.O.

EXAMPLE 1 : Connect Alarm In One with PIR (Passive Infrared).

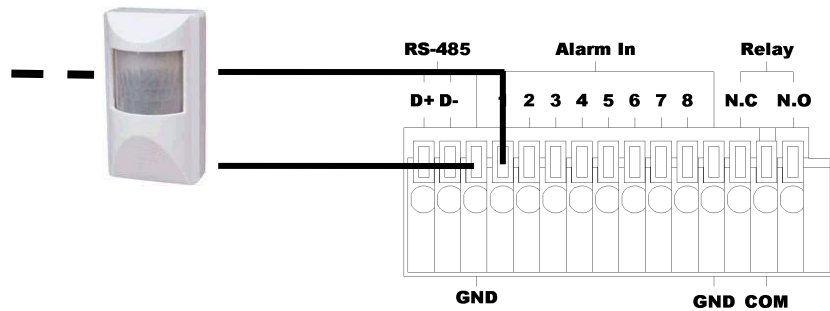



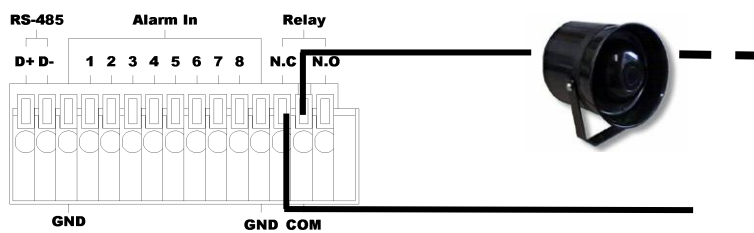



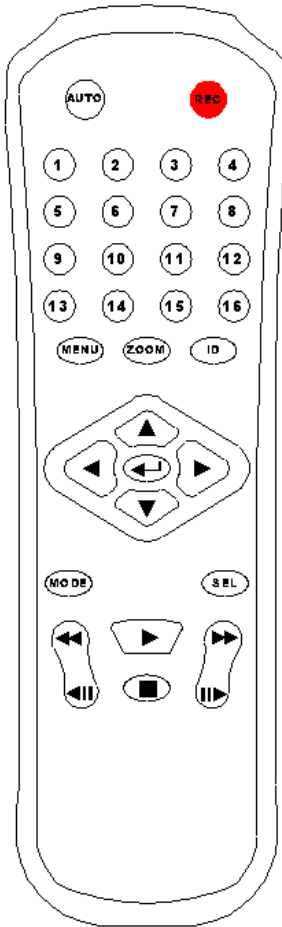



EXAMPLE 2 : Connect with Alarm Siren at Relay N.O.



2.5 IR REMOTE CONTROL



ITEM	
AUTO	Press AUTO to switch channel by channel automatically.
SEL	Press this button to select the different assembled of camera formats or perform PTZ functions. Moreover, under the 16 split screen and full screen modes, press this button for switching Audio ON/ OFF.
.REC	Press REC to start recording & again to stop.
1-16	Press the button to select the channel for full screen.
	Fast backward
	Picture by picture backward play
	Picture by picture forward play
	Fast forward
	Play video forward
MODE	Split Screen Switch
ID	**ID setup to control DVRs
	Switch split screen & Move upward or increase.
	Switch split screen & Move right or increase.
	Switch split screen & Move downward or decrease.
	Switch split screen & Move left or decrease.
	To enter item or make choose.
MENU	To into or exit main menu
STOP	Stop play and playback

2.6 PTZ (PAN, TILT AND ZOOM) CAMERA

Following diagram for DVR connect between PTZ camera & joystick controller, for DVR to control PTZ camera please make sure the CAMERA ID, BANDRATE (default at 9600 bps) and RS-485 cable.

2 CORE

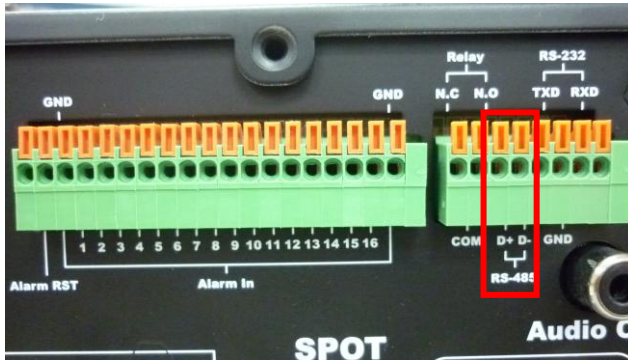

Under “Two Core” connection, controller can control speed dome without integrated protocol into DVR. Moreover, one keyboard can connect MAX 256 units of speed dome.

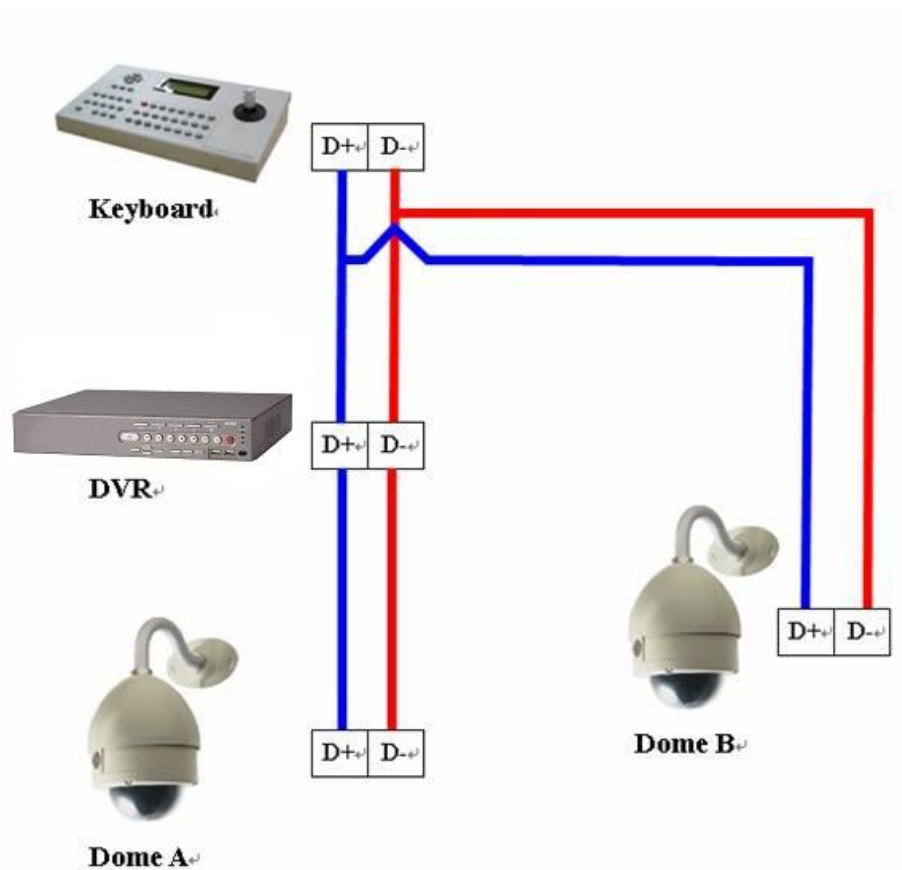

3 SYSTEM SETUP

3.1 MENU SETUP INTERFACE(GUI)



A.  CAMERA SET



B.  AUTHORITY SETUP

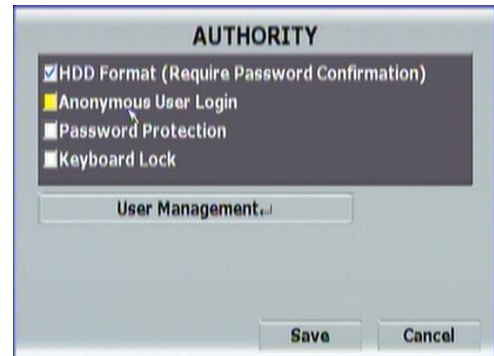

C.  NETWORK SETUP

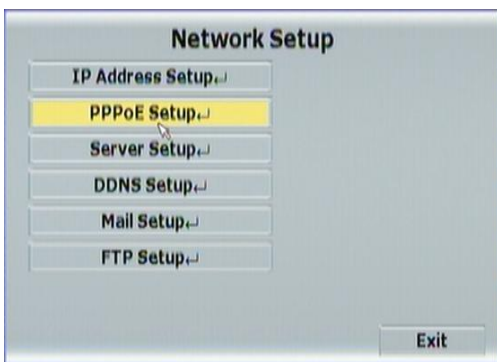

D.  SYSTEM SETUP

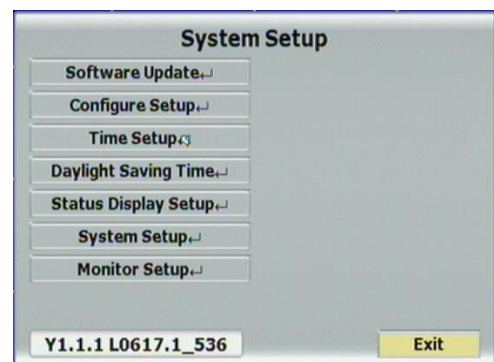



E. RECORD SETUP



F. DISK SETUP



G. ALARM SETUP







H. EXIT

3.2 LIVE VIEWING AND POP-UP MENU



NOTE : The pop-up menu can be activated by moving the mouse cursor to the bottom of the live viewing screen.

- A.**  **GUI MENU BAR**
With live viewing mode, press this button to get into the GUI menu.
- B.**  **DISK INFORMATION**
With live viewing mode, press this button to display disk information.
- C.**  **DIGITAL ZOOM**
In the full screen mode, left-click the button of the mouse to pull a range to zoom in or zoom out the image. User can right-click the button of the mouse to disable this function. (NOTE: Using the mouse to operate digital zoom can zoom in to max. 16 times.) Moreover, user can also use compound key on the front panel to perform this function. (First, click ENTER/COPY Key and then click ▲▼◀▶ key to select zoom in or zoom out position. Finally, click ENTER/COPY key again to complete the setting. Moreover, click MENU Key to disable digital zoom function. Using the panel key to perform zoom in function is fixed at 2 times.)
- D.**  **SPEED DOME CONTROLLER**
Within live-viewing mode, Clicks this button to get into the PTZ setup menu. User can also use PTZ key on the front panel to perform this function. Moreover, user can right-click the button of the mouse or press the PTZ key on the front panel again to exit PTZ Setup.

NOTE : Only for the camera supported PTZ function.

SPEED DOME CONTROL



 /  /  /  Direction key ;  Preset Point



 Minimize the Speed Dome Control panel;  Close the panel;

 Preset Point Patrol

 Focus & Zoom In/ Zoom Out & IRIS

PTZ Preset



PRESET POINTER NUMBER: Press  to save preset point number and its position;  to reserve the setting and  to delete preset point setup.

GO TO PRESET NUMBER: Press  to go to the setup preset point number position.

PTZ SETUP MENU

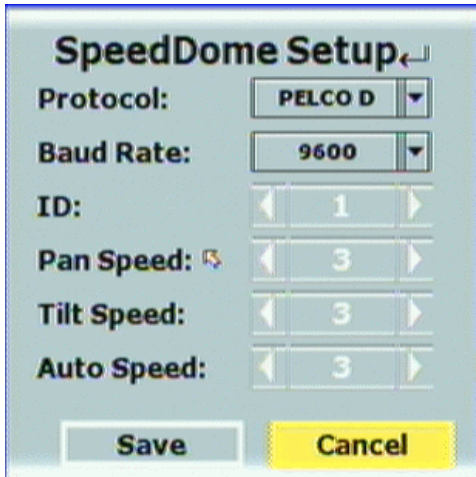

- PROTOCOL:** Use drop down list to change the connection protocol.
- BAUD RATE:** Use drop down list to change the BAUD rate.
- ID:** Use ◀ or ▶ button to setup the ID of connected PTZ camera.
- PAN SPEED:** Use ◀ or ▶ button wheel to change the left-right speed.
- TILT SPEED:** Use ◀ or ▶ button to change the up-down speed.
- AUTO SPEED:** Use ◀ or ▶ button to change the auto patrol speed.



E. AUDIO CONTROL

Press this button to turn the audio on or off.



F. DISPLAY CONTROL

Within live-viewing or playback mode, use display control to switch the camera channel.



G. RECORD AND PLAYBACK CONTROL

Same as front panel controller and remote controller.

3.3



CAMERA SETUP



Press ▲ or ▼ to select items.
 Press ◀ or ▶ to change values.
 Press SET to see more options.

A. CAMERA SETUP

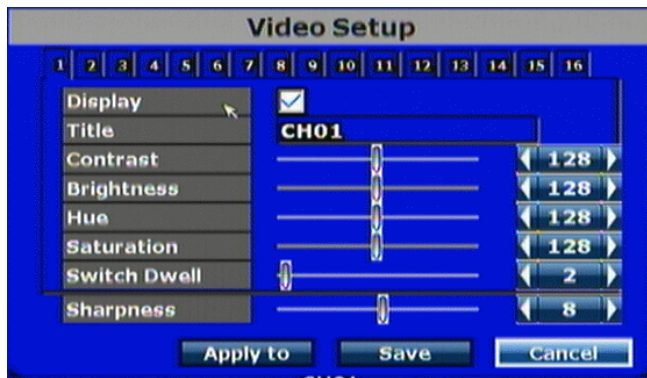

A-1. DISPLAY

Use the mouse to enable or disable the camera display.

A-2. TITLE

Press the mouse to change the name of the connected camera.

A-3. CONTRAST

Press ◀ or ▶ to change contrast level. The adjustment value is between 0~255

A-4. BRIGHTNESS

Press ◀ or ▶ to change brightness level. The adjustment value is between 0~255

A-5. HUE

Press ◀ or ▶ to change hue level. The adjustment value is between 0~255

A-6. SATURATION

Press ◀ or ▶ to change saturation level. The adjustment value is between 0~255

A-7. SWITCH DWELL

Press ◀ or ▶ to change auto switch second. The value is between 0~99 sec.

A-8. SHARPNESS

Press ◀ or ▶ / mouse wheel to change sharpness level. The adjustment value is between 0~15

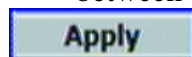

: Apply the above setting to other channel.

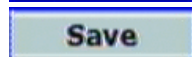

: Reserve the above setting.



: Cancel the above setting.

B. MOTION

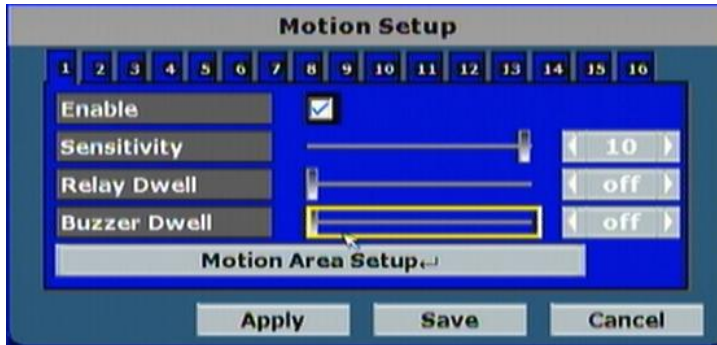

B-1. ENABLE

Use the mouse to enable or disable motion function.

B-2. SENSITIVITY

Press ◀ or ▶ to change sensitivity level.

B-3. RELAY DWELL

Press ◀ or ▶ to change the relay time or disable relay function.

B-4. BUZZER DWELL

Press ◀ or ▶ to change the buzzer time or disable buzzer function.

B-5. MOTION AREA SETUP

Press  to setup motion area.

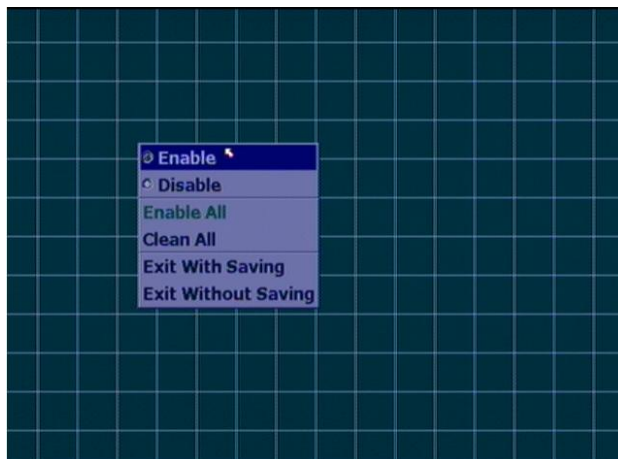

 **Apply**

: Apply the above setting to other channel.

 **Save**

: Reserve the above setting.

 **Cancel**

: Cancel the above setting.

C. PRIVACY SETUP

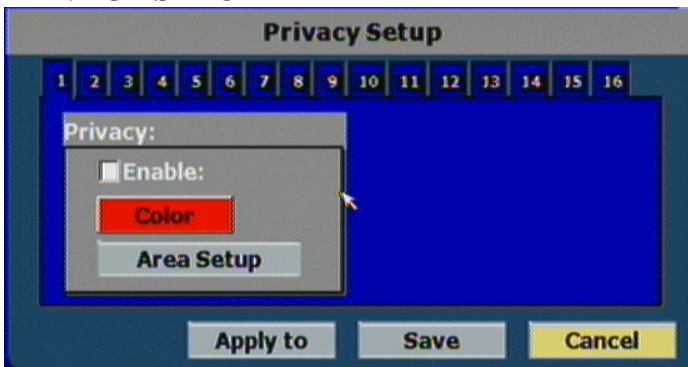

C-1. PRIVACY

Enable or disable “Privacy” function (Only in Live Image Mask). Click  to

select the “Privacy” color. There are black, gray, pink, red, brown, yellow, green, blue, dark blue and purple 10 variety colors can be chosen. Moreover, Click

Area Setup

can setup the “Shield” area.

D. SPEEDDOME SETUP



The image shows a 'SpeedDome Setup' dialog box with a blue background. At the top, there is a header 'SpeedDome Setup' and a row of 16 numbered buttons (1-16). Below this, there are several configuration fields: 'Protocol:' with a dropdown menu showing 'PELCO D'; 'Baud Rate:' with a dropdown menu showing '9600'; 'ID:' with a numeric input field showing '1' and left/right arrow buttons; 'Pan Speed:' with a numeric input field showing '3' and left/right arrow buttons; 'Tilt Speed:' with a numeric input field showing '3' and left/right arrow buttons; and 'Auto Speed:' with a numeric input field showing '3' and left/right arrow buttons. At the bottom, there are three buttons: 'Apply', 'Save', and 'Cancel'.

PROTOCOL: Use drop down list to change the connection protocol.

BAUD RATE: Use drop down list to change the BAUD rate.

ID: Use ◀ or ▶ button to setup the ID of connected PTZ camera.

PAN SPEED: Use ◀ or ▶ button wheel to change the left-right speed.

TILT SPEED: Use ◀ or ▶ button to change the up-down speed.

AUTO SPEED: Use ◀ or ▶ button to change the auto patrol speed.

Apply

: Apply the above setting to other channel.

Save

: Reserve the above setting.

Cancel

: Cancel the above setting.

3.4



AUTHORITY



Press ▲ or ▼ to select items.
 Press ◀ or ▶ to change values.
 Press SET to see more options.

A. HDD Format Check User Password

Use the mouse to click the checkbox to enable or disable inserting the user password while performing HDD Format.

B. Anonymous User Login

Use the mouse to click the checkbox to enable or disable login to the device with anonymous user.

C. Password Protection

Use the mouse to click the checkbox to enable or disable password protection function.

D. Keyboard Lock

Use the mouse to click the checkbox to enable or disable keyboard lock function.

E. User Management

Click the **User Management** button to entry management setting page.



E-1. Permission

Use the mouse to click the checkbox to modify and alter the user authority.

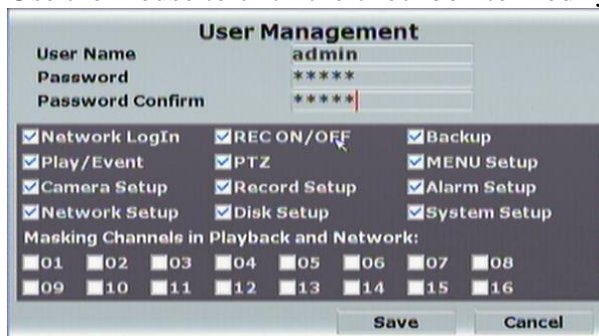

E-2. Add User

After click **Add User** button, the setup page will present in the following. The user can distribute the authority and the permission for the new user.

3.5



NETWORK SETUP

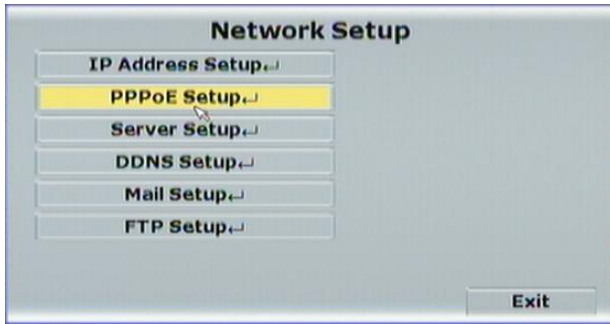

Press ▲ or ▼ to select items.
Press ◀ or ▶ to change values.
Press SET to see more options.

A. IP ADDRESS SETUP

Press ◀ or ▶ to DVR IP address.

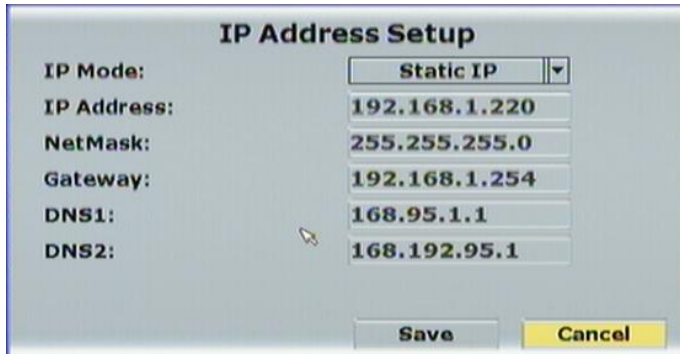

A-1. IP MODE

Press drop down list to change IP mode to STATIC IP or DHCP.

A-2. IP Address

Use the mouse to setup the DVR IP ADDRESS.

A-3. Network

Use the mouse to change SUBNET MASK.

A-4. Gateway

Use the mouse to change Default GATEWAY.

A-5. DNS1

Use the mouse to change DNS.

A-6. DNS2

Use the mouse to change OTHER DNS.

B. PPPoE SETUP

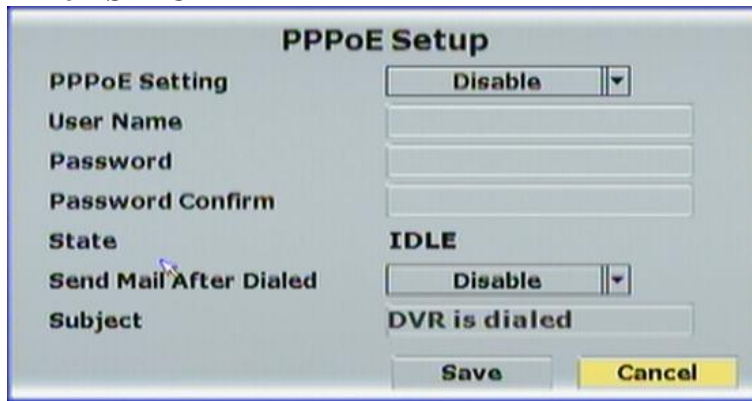

The screenshot shows a window titled "PPPoE Setup" with the following fields and controls:

- PPPoE Setting:** A dropdown menu currently set to "Disable".
- User Name:** An empty text input field.
- Password:** An empty text input field.
- Password Confirm:** An empty text input field.
- State:** A dropdown menu currently set to "IDLE".
- Send Mail After Dialed:** A dropdown menu currently set to "Disable".
- Subject:** A text input field containing the text "DVR is dialed".
- At the bottom, there are two buttons: "Save" and "Cancel".

B-1. PPPoE Setting

Press the drop down list to enable or disable PPPoE.

B-2. User Name

Insert the user name (ADSL account) which provided from local ISP.

B-3. Password

Insert the password which provided from local ISP.

B-4. re-Password

Insert the password again to confirm the password.

B-5. State

Present the current status of PPPoE function.

B-6. Send Mail After Dialed

Click the drop down list to enable or disable the function.

B-7. Subject

Insert the mail subject when dialed successfully.

C. SERVER SETUP

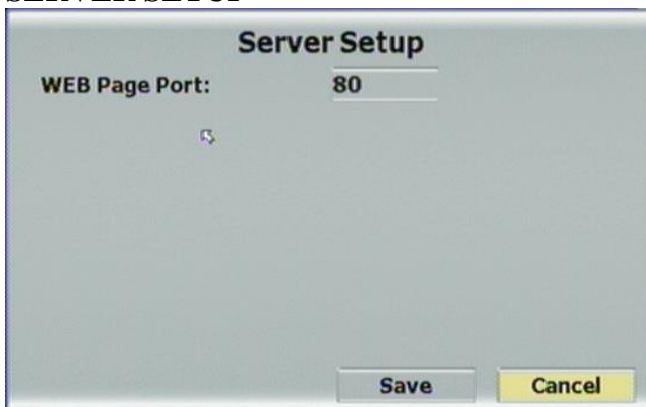

The screenshot shows a window titled "Server Setup" with the following field and controls:

- WEB Page Port:** A text input field containing the number "80".
- At the bottom, there are two buttons: "Save" and "Cancel".

C-1. WEB Page Port

Insert the port of web browser.

D. DDNS SETUP

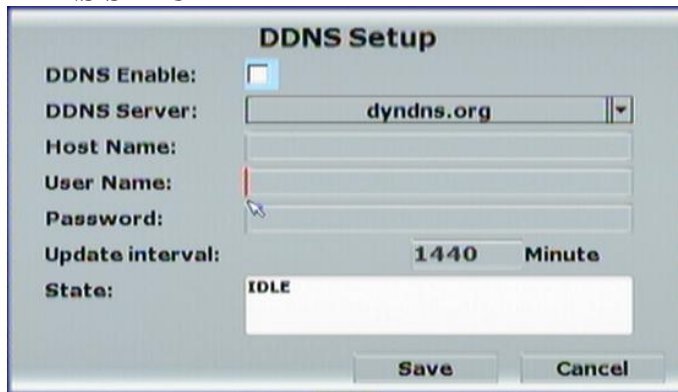

D-1. DDNS Enable

Click the checkbox to enable or disable DDNS function.

D-2. Provider

Click the drop down list to select DDNS provider.

D-3. Host Name

Insert the registered host name in the selected provider.

D-4. User Name

Insert the registered user name in the selected provider.

D-5. Password

Insert the registered password in the selected provider.

D-6. Update Interval

A period of time to update IP address.

D-7. State

The state after apply for DDNS.

Updating: Information update.

Idle: Stop service.

DDNS registered successfully, now log by

<http://<username>.ddns.camddns.com>: Registered successfully.

Updating Failed, the name is already registered.

Updating Failed, please check your internet connection.

E. MAIL SETUP

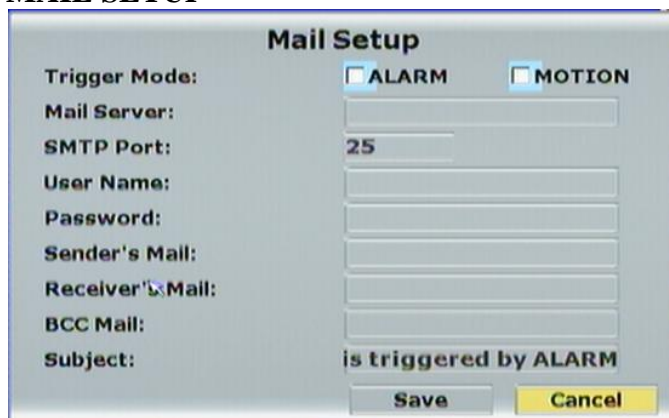

E-1. Trigger Mode

Click the checkbox to select the trigger mode. There are alarm and motion two modes.

E-2. Mail Server

The IP address of Mail Server

E-3. SMTP Port

The port of SMTP (known as Simple Mail Transfer Protocol). (Default value is 25)

E-4. User Name

The user name while log in to the mail server.

E-5. Password

The password while log in to the mail server.

E-6. Sender's Mail

The sender's account when send the mail via this mail server.

E-7. Receiver's Mail

The receiver's mail address.

E-8. BCC Mail

The receiver's mail address for Bcc Mail.

E-9. Subject

The subject while sending the mail.

F. FTP SETUP

The screenshot shows a 'FTP Setup' dialog box with the following fields and options:

- Trigger Mode:** Two checkboxes, 'ALARM' and 'MOTION', both of which are currently unchecked.
- FTP Server:** An empty text input field.
- User Name:** An empty text input field.
- Password:** An empty text input field.
- FTP Port:** A text input field containing the number '21'.
- Path:** A text input field containing the path '/ALARM/'.
- Buttons:** 'Save' and 'Cancel' buttons are located at the bottom right of the dialog.

F-1. Trigger Mode

Use the checkbox to select the trigger modes which are alarm and motion options.

F-2. FTP Server

The IP address of FTP Server.

F-3. User Name

The username while log in to the ftp server.

F-4. Password

The password while log in to the ftp server.

F-5. FTP Port

The port number of file transmission. (Default value is 21)

F-6. Path

The ftp path where the user wants to reserve the information.

3.6



SYSTEM SETUP

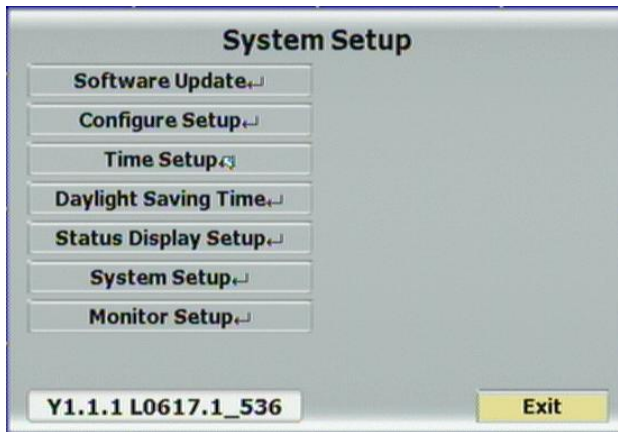

Press ▲ or ▼ to select items.
Press ◀ or ▶ to change values.
Press SET to see more options.

A. Software Update

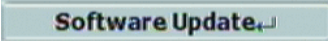
Click  button to perform firmware updating.

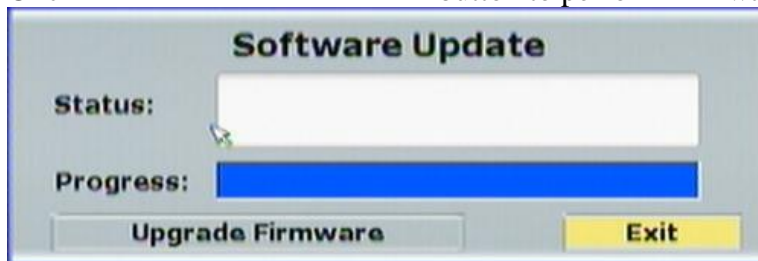

Click  to start software update.

B. Configure Setup

Click the checkbox to select which item can be setup by the user. The user can also load the setting to factory default, load the configure from USB and backup configure to USB.

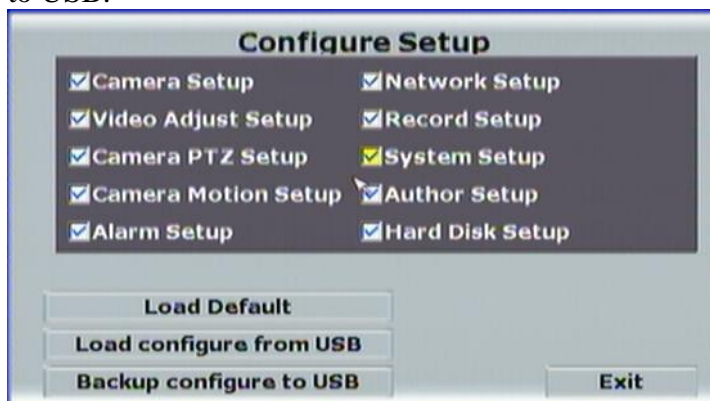

C. Time Setup

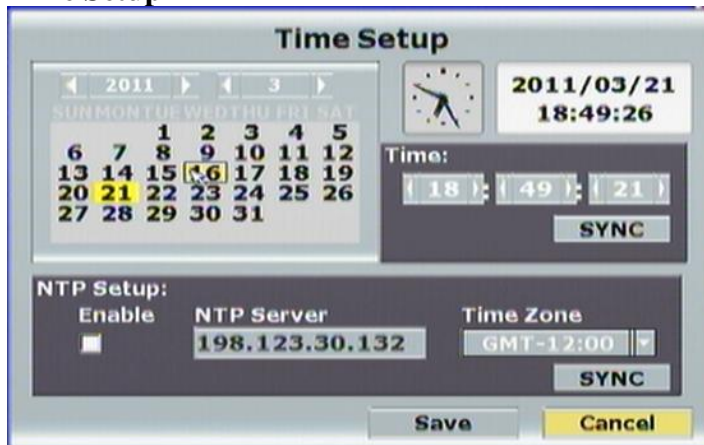

Click **SYNC** button within “Time” block can adjust and synchronize the time of the dvr as the system time of the PC. Moreover, if the user clicks the enable checkbox and **SYNC** button within the NTP Setup block, the time of the DVR will synchronize as the NTP Server.

D. Daylight Saving Time



After enable the daylight saving time function, the user can use the drop down list to select the start time and the end time of daylight saving time. After complete the setting, please click **Save** button to reserve the setting.

E. Status Display Setup

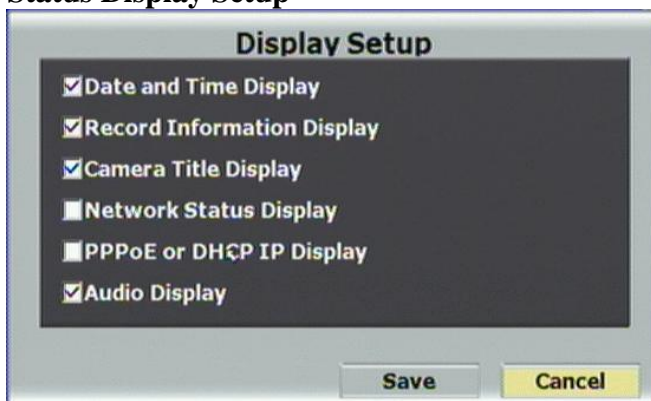

Use the mouse to click the display setup items, which is including “Date and Time Display”, “Record Information Display”, “Camera Title Display”, “Network Status Display”, “PPPoE or DHCP IP Display” and “Audio Display”.

F. System Information

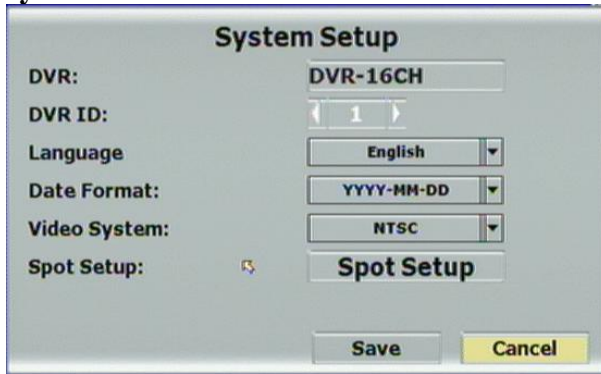

The System Setup dialog box contains the following fields and controls:

- DVR: DVR-16CH
- DVR ID: 1
- Language: English
- Date Format: YYYY-MM-DD
- Video System: NTSC
- Spot Setup: Spot Setup
- Buttons: Save, Cancel

F-1. DVR Name

Use the virtual keyboard to insert the name of the DVR.

F-2. DVR ID

Use ◀ or ▶ to setup the DVR ID. The adjustment value is between 0~32

F-3. Language

Use the drop down list to change the DVR language. Currently, there are English, Traditional Chinese and Simplified Chinese three options.

F-4. Date Format

Use the drop down list to change DATE. There are DD/MM/YYYY, YYYY/MM/DD and MM/DD/YYYY three modes.

F-5. Video System

Use the drop down list to change system type, NTSC or PAL. Moreover, **DVR will reboot** while changing the system type.

F-6. Spot Setup

Setup the display time for all channels at once - Spot monitor will switch the display time at same time.

Setup the display time for each channel individually- Spot monitor will switch the display time to each channel refer to the settings

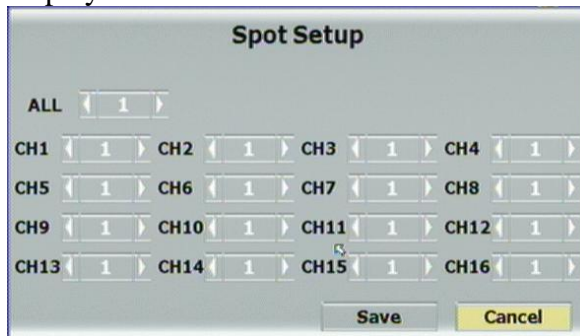

The Spot Setup dialog box contains the following fields and controls:

- ALL: 1
- CH1: 1, CH2: 1, CH3: 1, CH4: 1
- CH5: 1, CH6: 1, CH7: 1, CH8: 1
- CH9: 1, CH10: 1, CH11: 1, CH12: 1
- CH13: 1, CH14: 1, CH15: 1, CH16: 1
- Buttons: Save, Cancel

G. Monitor Setup

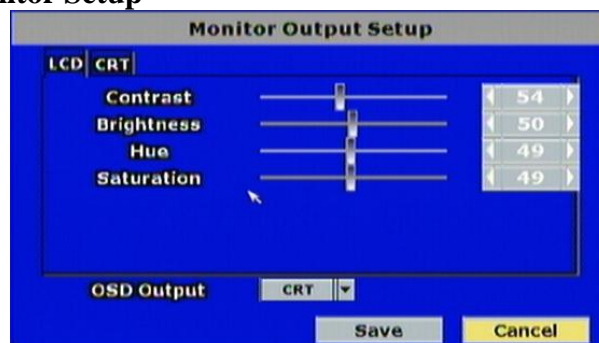

The Monitor Output Setup dialog box contains the following fields and controls:

- Monitor Type: LCD | CRT
- Contrast: 54
- Brightness: 50
- Hue: 49
- Saturation: 49
- OSD Output: CRT
- Buttons: Save, Cancel

User can use ◀ or ▶ to adjust the monitor related setting within this page, there are “Brightness”, “Contrast”, “Hue”, “Sharpness” and “Saturation” five options can be set.



RECORD SETUP



A. AUDIO RECORD

Use the mouse to enable or disable the audio record function.

B. PRE-ALARM RECORDING MODE

Press ◀ or ▶ to change pre-alarm recording time which from 5~99 sec.

C. POST-ALARM RECORDING TIME

Press ◀ or ▶ to change post-alarm recording time which from 5~99 sec.

D. RECORD MODE

Use the mouse to click drop down list to change record mode. There are Manual, Schedule and Alarm Trigger 3 modes.

E. WATER MARK SETUP

Use the checkbox to enable or disable time water mark. Moreover, use the drop down list to decide the position of the time water mark.

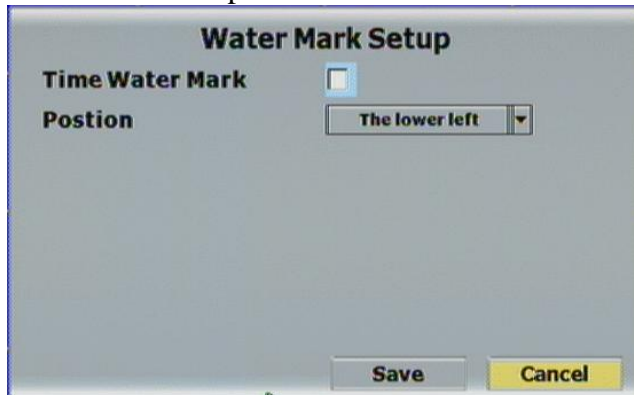

D. MORMAL/ ALARM RECORD SETUP

Click **Normal/Alarm Record Setup** button to setup normal or alarm record.

D-1. NORMAL RECORD SETUP

Among normal record tag, user can change resolution, quality and FPS in each channel manually. Moreover, user can select resolution, quality in “ALL” option at once and click “AVERAGE” to set PPS automatically. NOTE: If record resolution is altered in here, **DVR will reboot** automatically.

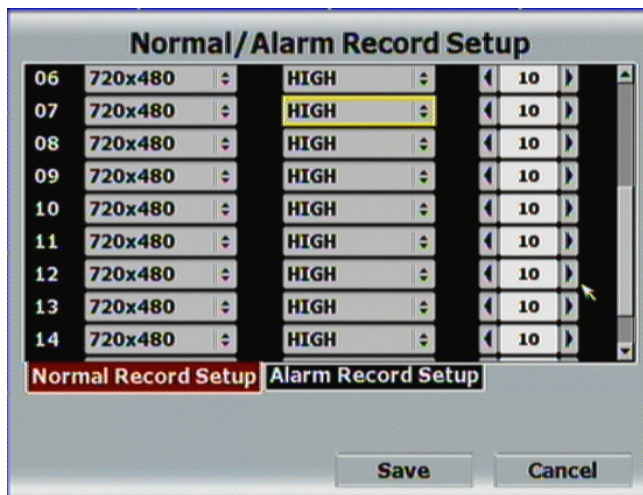

D-2. ALARM RECORD SETUP

Among alarm record tag, the resolution setting is the same as normal record setup. User can adjust the quality and FPS in each channel manually. Moreover, user can select resolution, quality in “ALL” option at once and click “AVERAGE” to set FPS automatically.

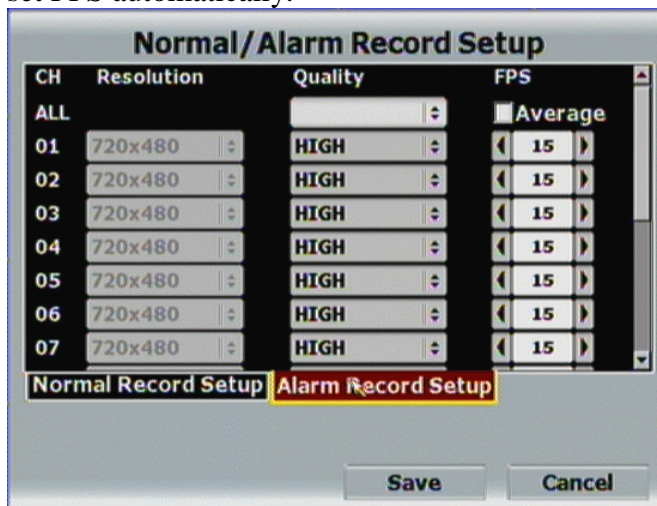

E. SCHEDULE SETUP

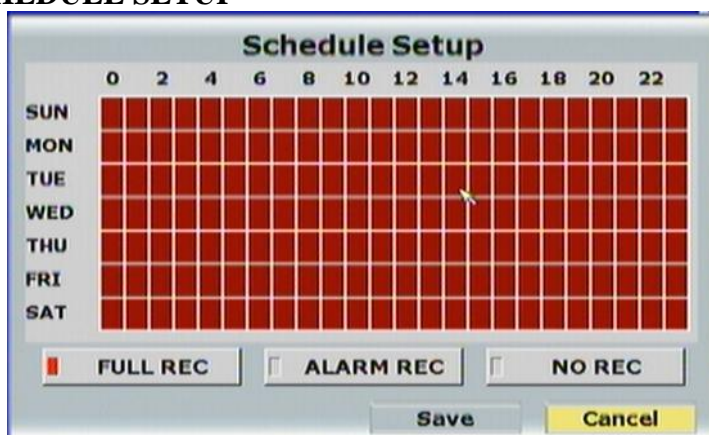

Use the mouse to select the schedule setting which is including day, time and schedule mode of recording. Red is presented to full time recording, yellow is revealed alarm recording and no recording is in green.

3.8



HDD MANAGEMENT



Press ▲ or ▼ to select items.
 Press ◀ or ▶ to change values.
 Press SET to see more options.

A. OVERWRITE MODE

Click the drop down list to enable or disable overwrite function.

B. HARD DISK FULL WARNING

Click the drop down list to change value to 20/ 15/ 10 or 5% with non-overwrite mode. When LEFT RATIO is below the setting, it will enable AUDIBLE ALARM (If AUDIBLE ALARM of BUZZER of ALARM SETUP is ON).

C. AUTO DELETION

Click the drop down list to enable or disable auto deletion function.

D. RESERVE DAY

Use ◀ or ▶ to setup the reserve day. While enable auto deletion function, the data will be removed when reserve day is exceed the setting. The value can be setup between 1~30 days.

E. STORAGE INFORMATION

The information of storage device will present in this page.

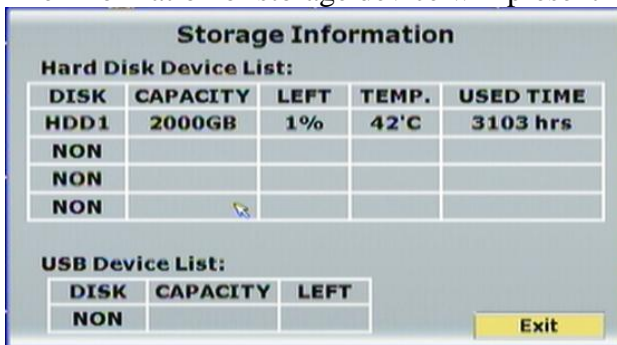

F. FORMAT HDD

Insert the user name and password while performing HDD format function.



3.9



ALARM SETUP



Press ▲ or ▼ to select items.
Press ◀ or ▶ to change values.
Press SET to see more options.

A. ALARM TRIGGER SETUP



A-1. HDD TEMP. WARNING

Enable or disable the hard disk over-heated warning function.

A-2. HDD TEMP. LIMIT

Press ◀ or ▶ to change hard disk temperature limitation. The adjustment value is between 45~70 sec.

A-3. ALARM AUTO SWITCH

Click the drop down list to change alarm auto switch. There are disable, full screen and split screen.

A-4. VIDEO LOSS DETECT

Click the drop down list to enable or disable video loss detection.

A-5. EXT. ALARM DETECT

Click the drop down list to enable or disable external alarm detection.

A-6. EXT. ALARM POLE

When the alarm is setup in normal close, please select “N.C.” option in alarm pole. In contrast, when the alarm is setup in normal open, please select “N.O.” option.

B. ALARM OUTPUT SETUP

Press ◀ or ▶ to setup buzzer and relay time.

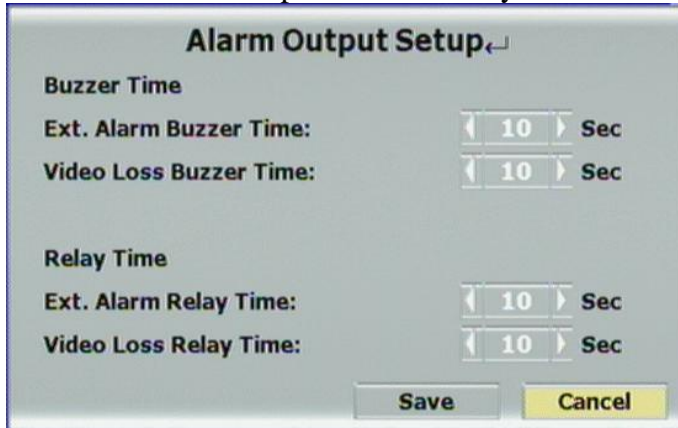

The image shows a dialog box titled "Alarm Output Setup". It is divided into two sections: "Buzzer Time" and "Relay Time". Under "Buzzer Time", there are two rows: "Ext. Alarm Buzzer Time:" and "Video Loss Buzzer Time:", each with a numeric input field set to "10" and a "Sec" label. Under "Relay Time", there are two rows: "Ext. Alarm Relay Time:" and "Video Loss Relay Time:", each with a numeric input field set to "10" and a "Sec" label. At the bottom right, there are two buttons: "Save" and "Cancel".

B-1. BUZZER TIME

Use ◀ or ▶ to setup the external alarm buzzer time. The value can be adjusted from off ~99 sec.

Use ◀ or ▶ to setup the buzzer time when video loss happens. The value can be adjusted from off ~99 sec.

B-2. RELAY TIME

Use ◀ or ▶ to setup the external alarm relay time. The value can be adjusted from off ~99 sec.

Use ◀ or ▶ to setup the relay time when video loss happens. The value can be adjusted from off ~99 sec.

C. ALARM EVENT SETUP

There are 8 events can be selected, when these items are selected, these events will be reserved and revealed in playback log. The supported event items are presented in the following image,



The image shows a dialog box titled "Alarm Event Setup". It contains a list of eight events, each with a checked checkbox: "Power On Event", "Power Off Event", "Video Loss Event", "Ext. Alarm Event", "Motion Event", "Record Event", and "Stop Record Event". At the bottom, there are two buttons: "Save" and "Cancel".

4 DVR PLAYBACK

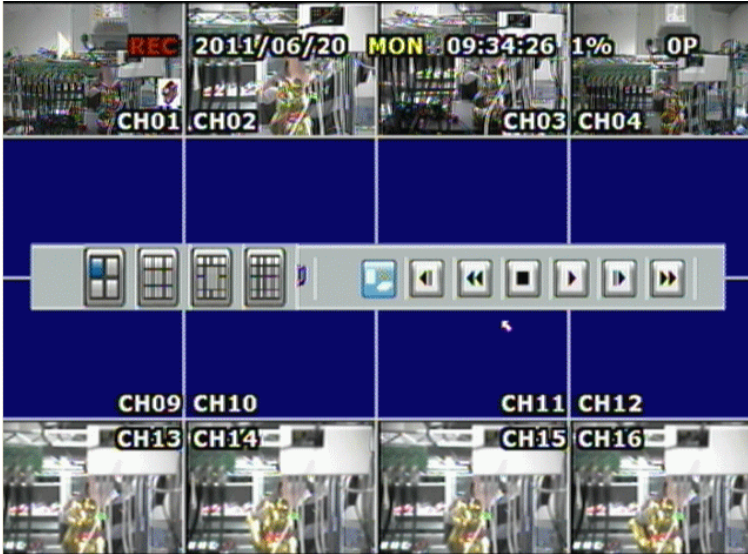

Click the playback button on the pop-up menu.

Note: the pop-up menu can be activated by moving the mouse cursor to the bottom of the live viewing screen.

- A.  **DISPLAY CONTROL**

Within playback mode, use display control to switch the camera channel.

- B.  **AUDIO CONTROL**

Press this button to turn the audio on or off

- C.  **RECORD BACKUP**

With playback mode, press this button to backup record (.264 video backup) and press this button again to finish backup. For performing the single image backup (.Y42 single image backup), press  first and then click this button to backup the necessary image.

- D.  **RECORD AND PLAYBACK CONTROL**

Same as front panel controller and remote controller.

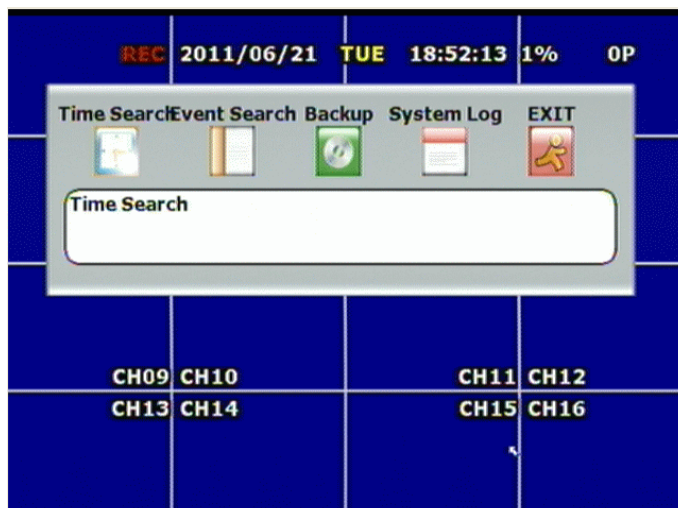



4.1 TIME SEARCH

Select the time which is going to playback (including the date and the time) and then click **Start Play** button to start playback. If the time includes the recorded data, the color of the time bar will reveal in red.

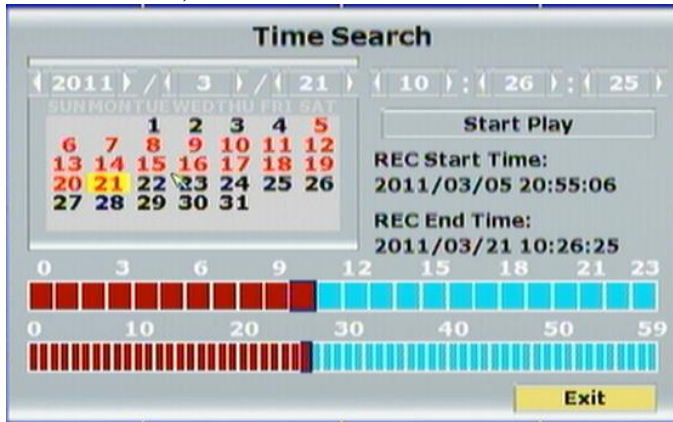

4.2 EVENT SEARCH

After entry to the “Event Search” page, the user can click the revealed event(s) to perform the playback or click **Event Filter** button to setup the advanced event search.



4.3



BACKUP

After click “BACKUP” button, use the drop down list to select “Media Device” which has USB and DVD-RW (in 08CH and 16CH models) two options. Moreover, “Hours Mode” and “Time Mode” can be selected in here.

Time Mode

Use ◀ or ▶ to select the start and end time of backup. Then, click

Backup

button to start backup.

Backup

REC Start Time: 2011/03/05 20:55:06

REC End Time: 2011/03/21 10:26:25

Media Device: NO Free Size:

Start Time: 2011 / 3 / 21 10 : 26 : 0

End Time: 2011 / 3 / 21 10 : 26 : 0

Backup Size:

Select channel

<input checked="" type="checkbox"/> CH 1	<input checked="" type="checkbox"/> CH 2	<input checked="" type="checkbox"/> CH 3	<input checked="" type="checkbox"/> CH 4
<input checked="" type="checkbox"/> CH 5	<input checked="" type="checkbox"/> CH 6	<input checked="" type="checkbox"/> CH 7	<input checked="" type="checkbox"/> CH 8
<input checked="" type="checkbox"/> CH 9	<input checked="" type="checkbox"/> CH 10	<input checked="" type="checkbox"/> CH 11	<input checked="" type="checkbox"/> CH 12
<input checked="" type="checkbox"/> CH 13	<input checked="" type="checkbox"/> CH 14	<input checked="" type="checkbox"/> CH 15	<input checked="" type="checkbox"/> CH 16

Check Device Backup Exit

4.4 SYSTEM LOG

System log reserves all the logs. The maximum number of reserved log is 2000. Moreover, click “Log Filter” button can select which sort of logs that will show in the system log page.



Click  to exit the Playback Setup page.

5 BACKUP PLAYBACK

SYSTEM REQUIREMENT

CPU: Intel Celeron 1.6G

MEMORY: 256MB.

VGA: 32MB

VGA RESOLUTION: 1024 x 768.

OS: Windows XP / 2000

SUGGESTED REQUIREMENT

CPU: Intel P4 2.8G

MEMORY: 512MB or above

VGA: 64MB or above

VGA RESOLUTION: 1024 x 768

OS: Windows XP / 2000

5.1 MAIN SCREEN SETTING

A. MAIN SCREEN

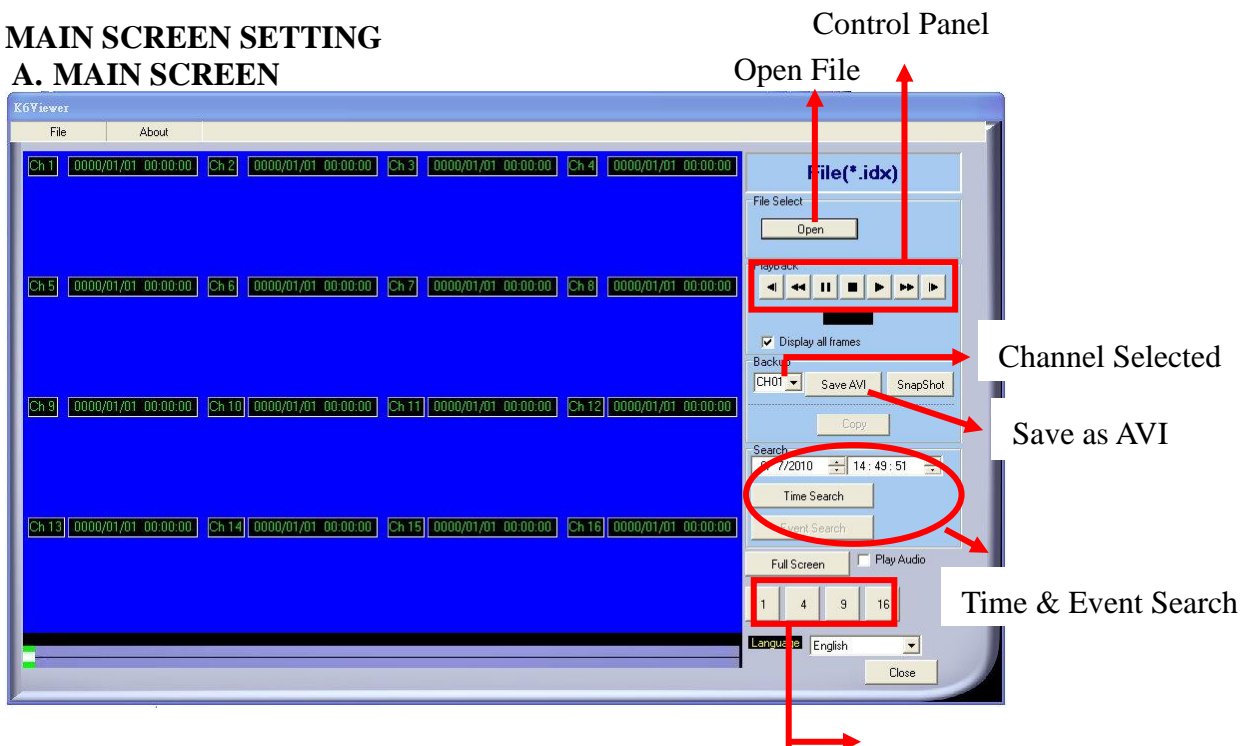

B. HDD PLAY

Play about all the data from the Hard disk of DVR or perform the specific Time and Event Search to play.

Note: Remove the DVR HDD and connect to the PC first. Then, use DVR

player (K6Viewer.exe) to play the data of HDD. DVR player (K6Viewer.exe) can be attained from the attached CD or via the Internet; moreover, while performing USB backup and DVD-RW backup, the software will be built automatically as well.

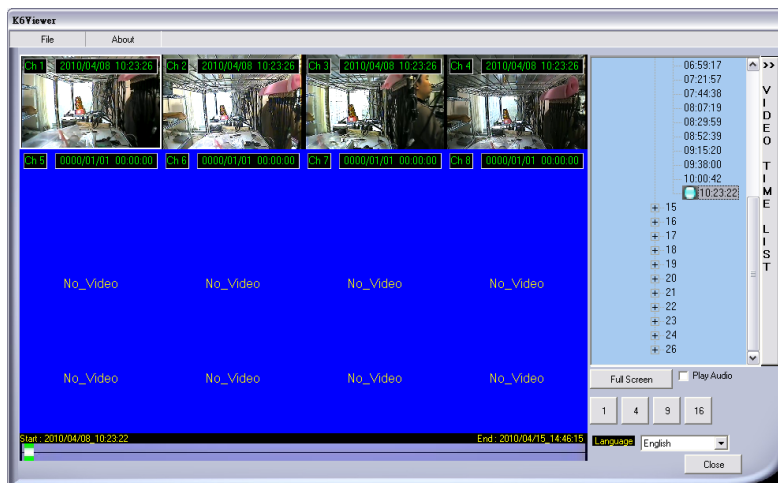
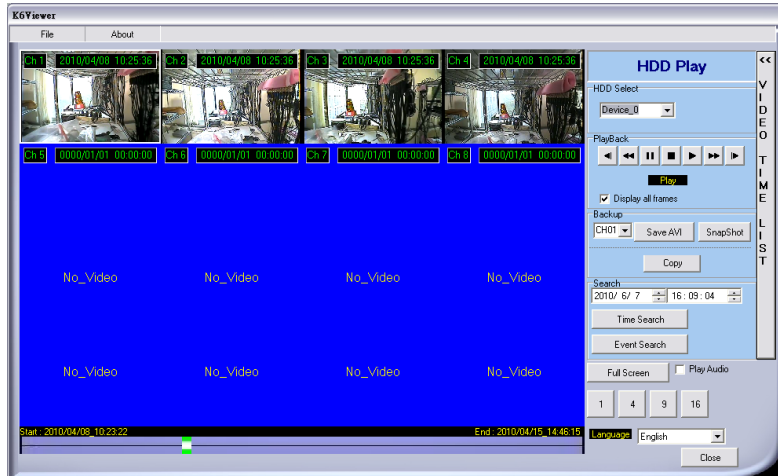

B-1. TIME SEARCH

Insert search Date and Time and then click **Time Search** to play all the searched film.

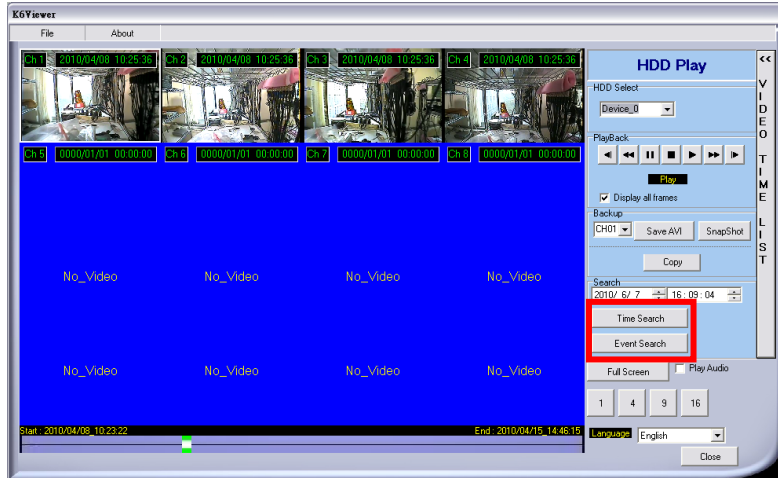

B-2. EVENT SEARCH

It will display all the events which are reserved within the DVR HDD after press **Event Search** (Shown in the following) and double click left button of mouse to trigger event.

Num	Channel	Time	Type
1	255	2008/02/25_09:53:29	POWER ON
2	255	2008/02/25_09:53:38	POWER ON
3	255	2008/02/25_09:54:56	POWER ON
4	255	2008/02/25_09:56:09	POWER ON
5	255	2008/02/25_09:58:05	POWER ON
6	255	2008/02/25_10:02:45	POWER ON
7	255	2008/02/25_10:13:05	POWER ON
8	255	2008/02/25_10:15:33	POWER ON
9	255	2008/02/25_10:35:06	POWER ON
10	255	2008/02/25_10:37:42	POWER ON
11	255	2008/02/25_10:47:21	POWER ON
12	255	2008/02/25_10:49:25	POWER ON
13	255	2008/02/25_10:51:11	POWER ON
14	255	2008/02/25_10:54:16	POWER ON
15	255	2008/02/25_10:58:08	POWER ON
16	255	2008/02/25_11:00:02	POWER ON
17	255	2008/02/25_11:04:15	POWER ON
18	255	2008/02/25_11:09:35	POWER ON
19	255	2008/02/25_10:28:44	POWER ON

B-3. HDD COPY

Copied and reserved the DVR HDD data to other data storage device.

Press **Copy** button, the Copy screen will pop-up.

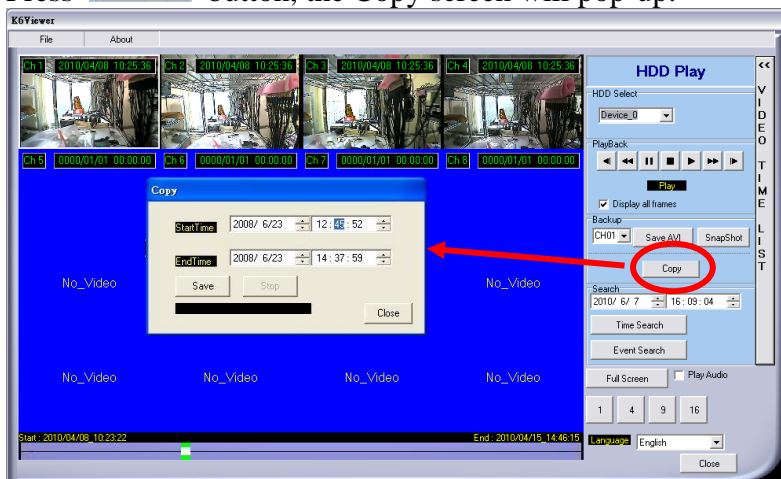

Then, select the “StartTime” and “EndTime”.

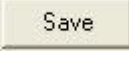

After that, press  button to choose the storage destination and press  to start reserving.

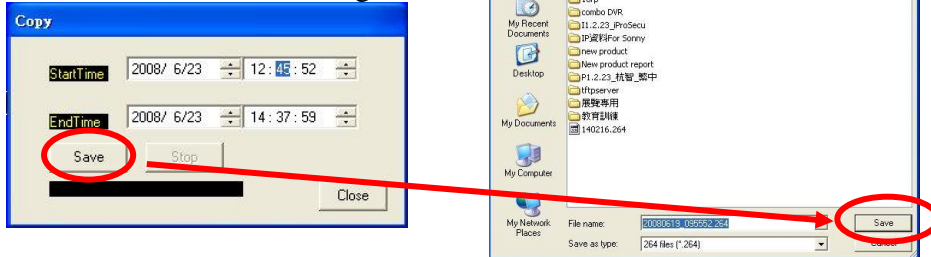

Finally, the complete information will pop-up while finished storage.



(K6 Viewer.exe) can play not only DVR H.D.D (*.idx). but also the *.264 and *.Y42 files which are reserved within the data storage devices. (i.e. CD/DVD disc, pen drive and the PC H.D.D which the data backup from DVR H.D.D)

C. File (*.264) Play

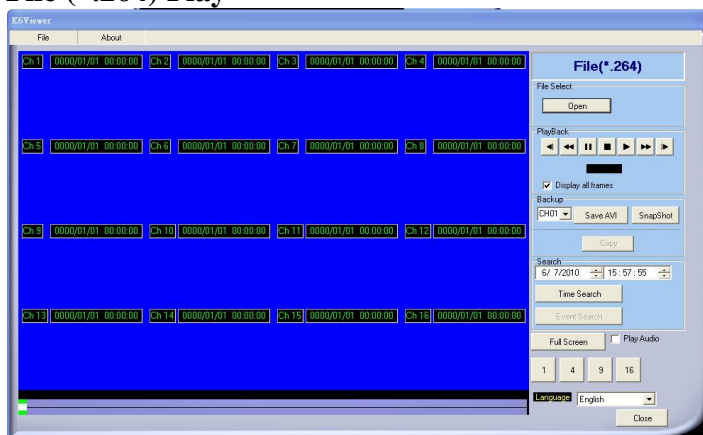

D. File (*.Y42) Play

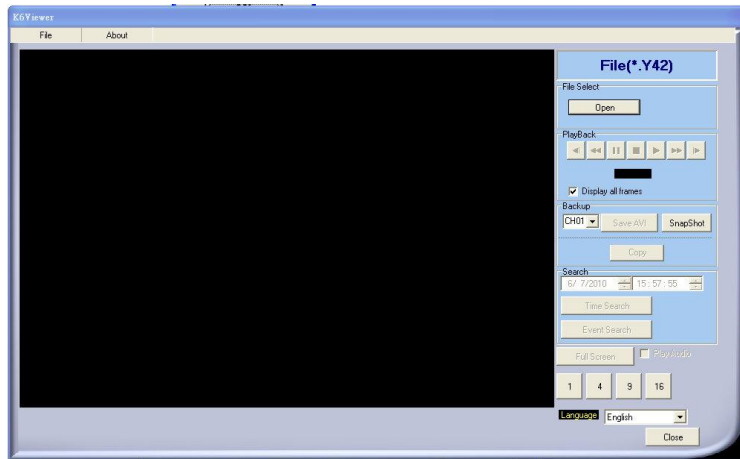

5.2 USB & LOCAL BACKUP FILE PLAYBACK

A. Plug the USB disk into PC or check the local backup folder.

If using USB mode, please double click the player.exe from the pop-up diagram. (As below)

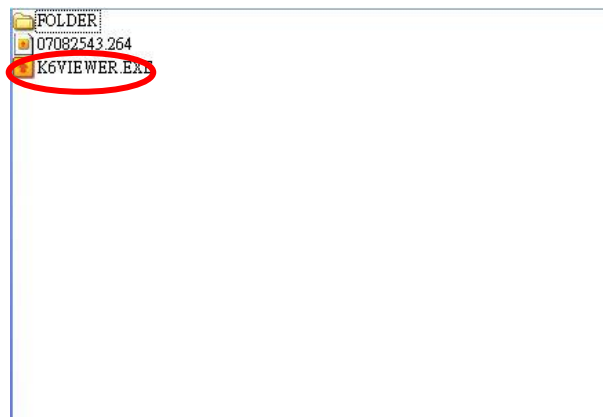

B. The play backup program would appear on the screen, select "Open".

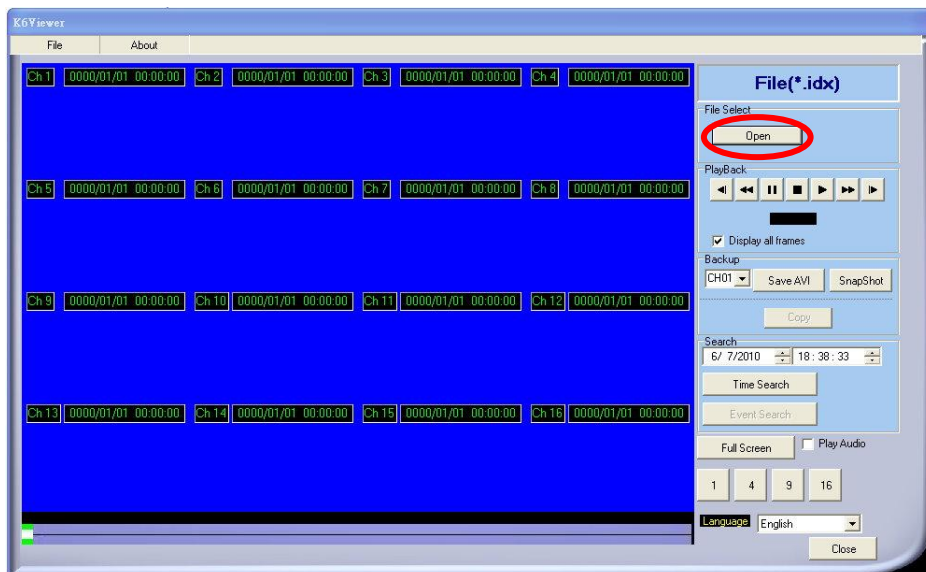

C. Open the USB disk located driver letter. (Example E:) or the local backup folder, and pick the file to playback.

The backup file will named as the time when backup, as like:
170319.264 will be 17:03:19

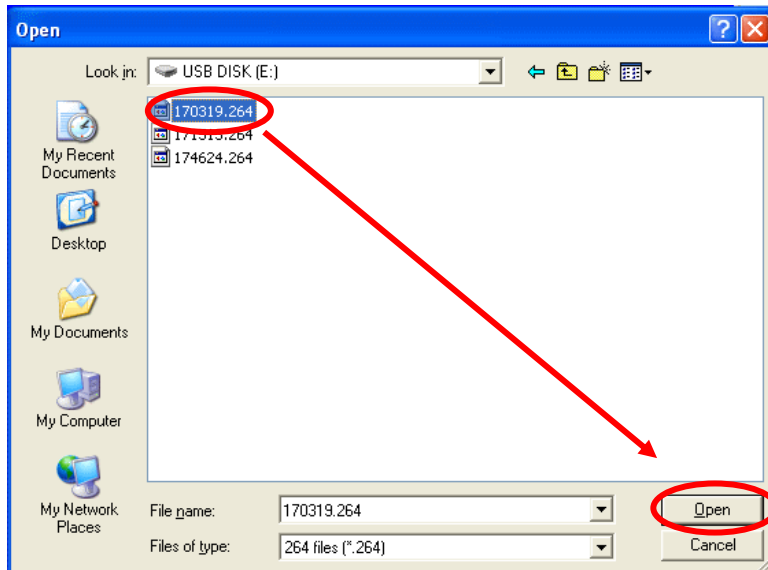



D. Press the play icon to play the video or still picture.

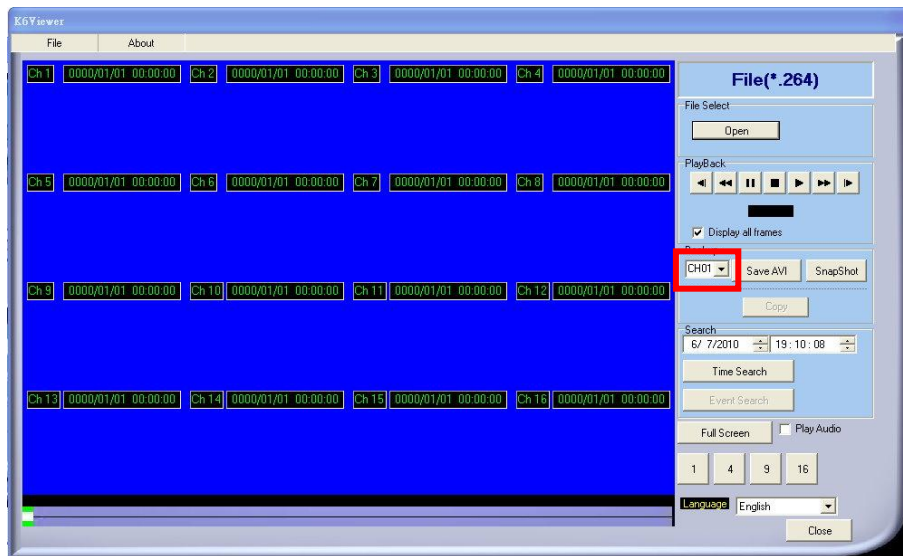

5.3 BACKUP FILE TO AVI

A. Please select specific channel to backup.



B. During video playback mode please press AVI bottom  to start.

C. Make up a filename and path than press  bottom to start AVI backup.

D. Press AVI bottom  to finish backup.

6 NETWORK VIEWING & PLAYBACK

SYSTEM REQUIREMENT

CPU: Intel Celeron 1.6G

MEMORY: 256MB.

VGA: 32MB

VGA RESOLUTION: 1024 x 768.

OS: Windows XP / 2000

SUGGESTED REQUIREMENT

CPU: Intel P4 2.8G

MEMORY: 512MB or above

VGA: 64MB or above

VGA RESOLUTION: 1024 x 768

OS: Windows XP / 2000

6.1 IP ADDRESS SETUP ON PC SITE

Install cameras inside in LAN or use network cable to connect with PC. This is for IPInstallerEng.exe to set up IP address of cameras. If OS is Windows XP SP2 or above, the following Windows Security Alert will popup. Then, please click on **Unblock**.

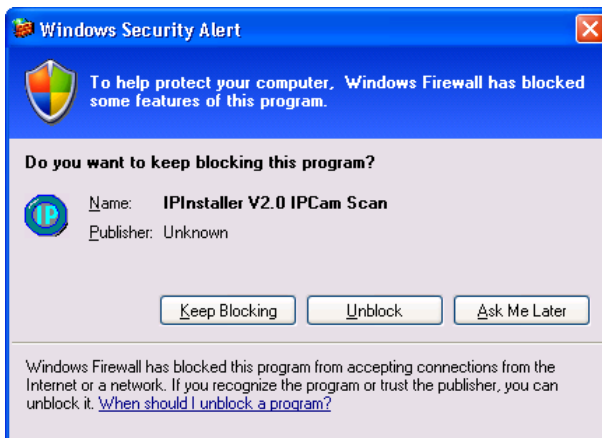

Then, IPInstallerEng.exe will popup:
DVR default IP address is 192.168.1.220

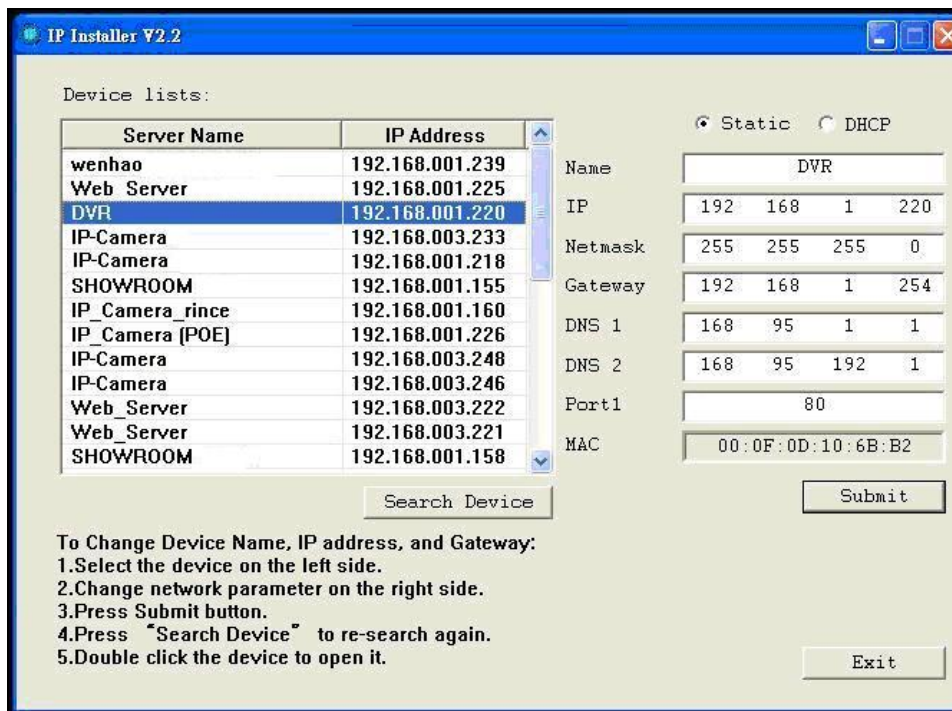

NOTE: Please input correct network parameters without blank spaces.

On Device Lists, it lists all servers. Click on one server and then its IP setting will show on the right side. After editing the parameters and clicking on Submit, the following dialogue box will popup. And, it will reboot the device with new parameters.

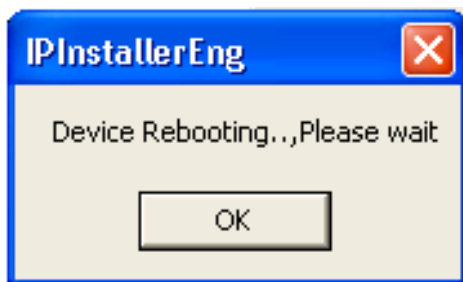

6.2 OPTIONAL MICROSOFT INTERNET EXPLORER SETUP

OPTION 1: DISABLE ACTIVEX WARNING

- A. IE → Tools → Internet Options → Security → Custom Level → Security Settings → Download unsigned ActiveX controls → Enable or Prompt (recommend).
- B. IE → Tools → Internet Options → Security → Custom Level → Security Settings → Initialize and script ActiveX controls not marked as safe → Enable or Prompt (recommend).

1

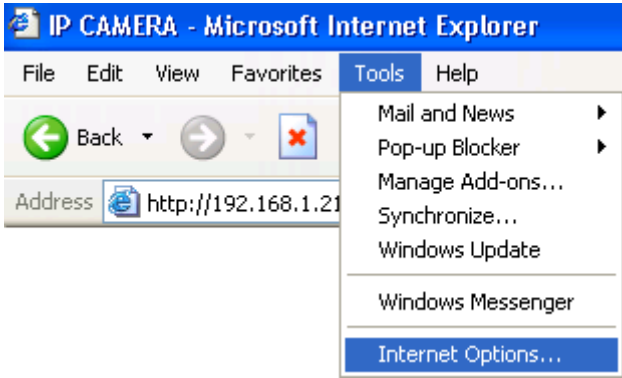

2

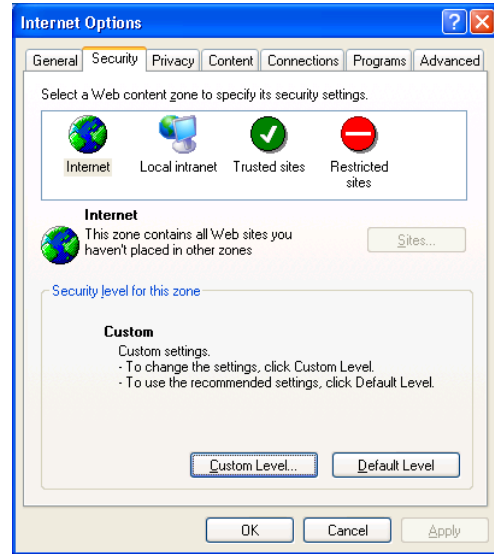

3

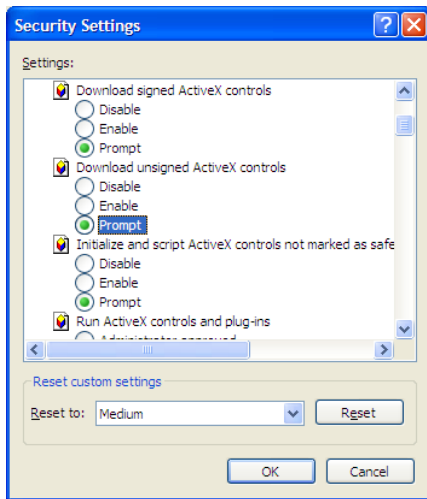

4

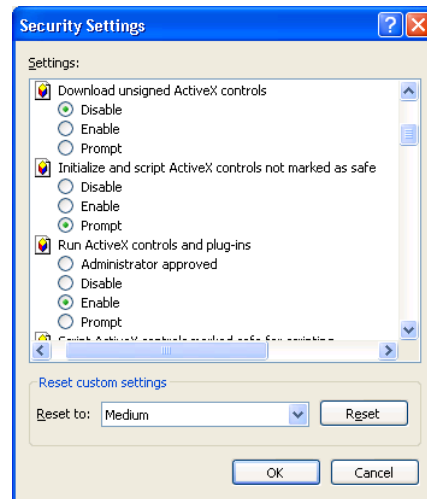

5

Above three options are all based on select as the prompt.
As indicated in the dialogue box. Please select "YES."

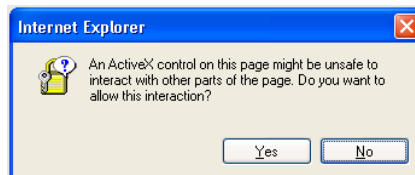

OPTION 2: ADD TO TRUSTED SITES

IE → Tools → Internet Options → Security → Trusted sites → Sites

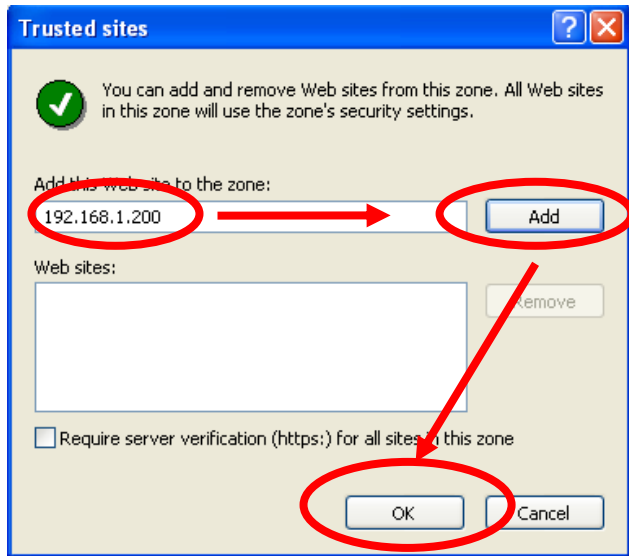
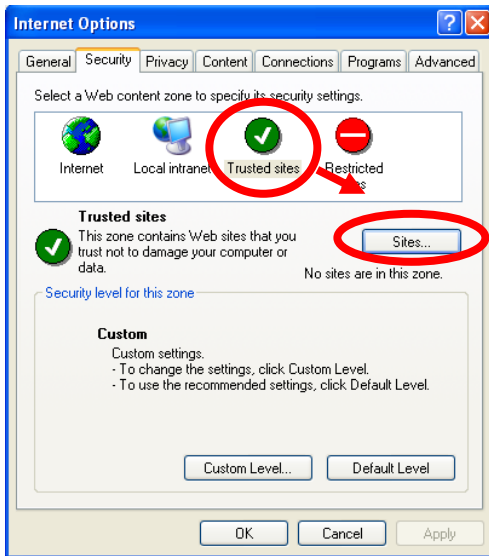

6.3 LOGIN

A. INSTALL ACTIVE X

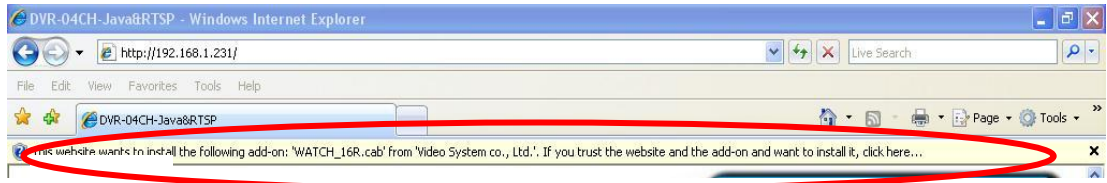

B. START INSTALL ACTIVE X

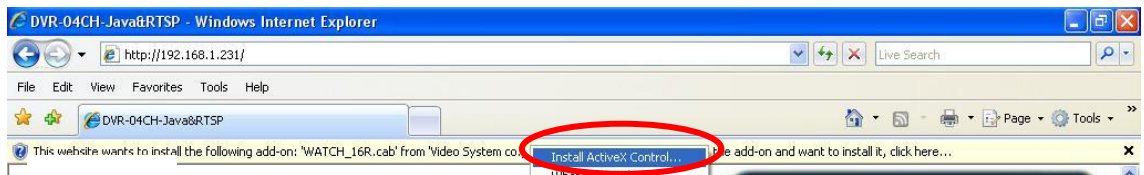

C. ACCOUNT & PASSWORD LOGIN

After IP setup and connect to network or LAN, type IP address on IE Browser directly. The following User name & Password Login window will popup.

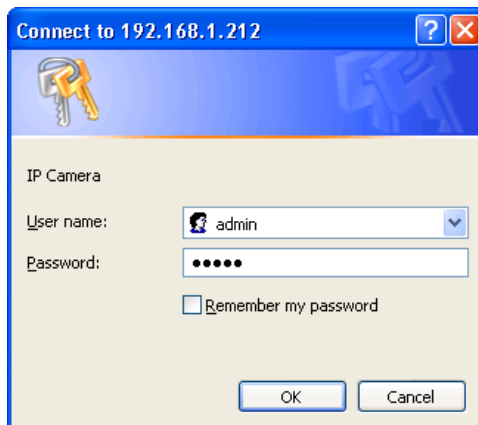

Default user name: admin

Default password: admin

6.4 REMOTE CONTROL

LIVE VIEWING

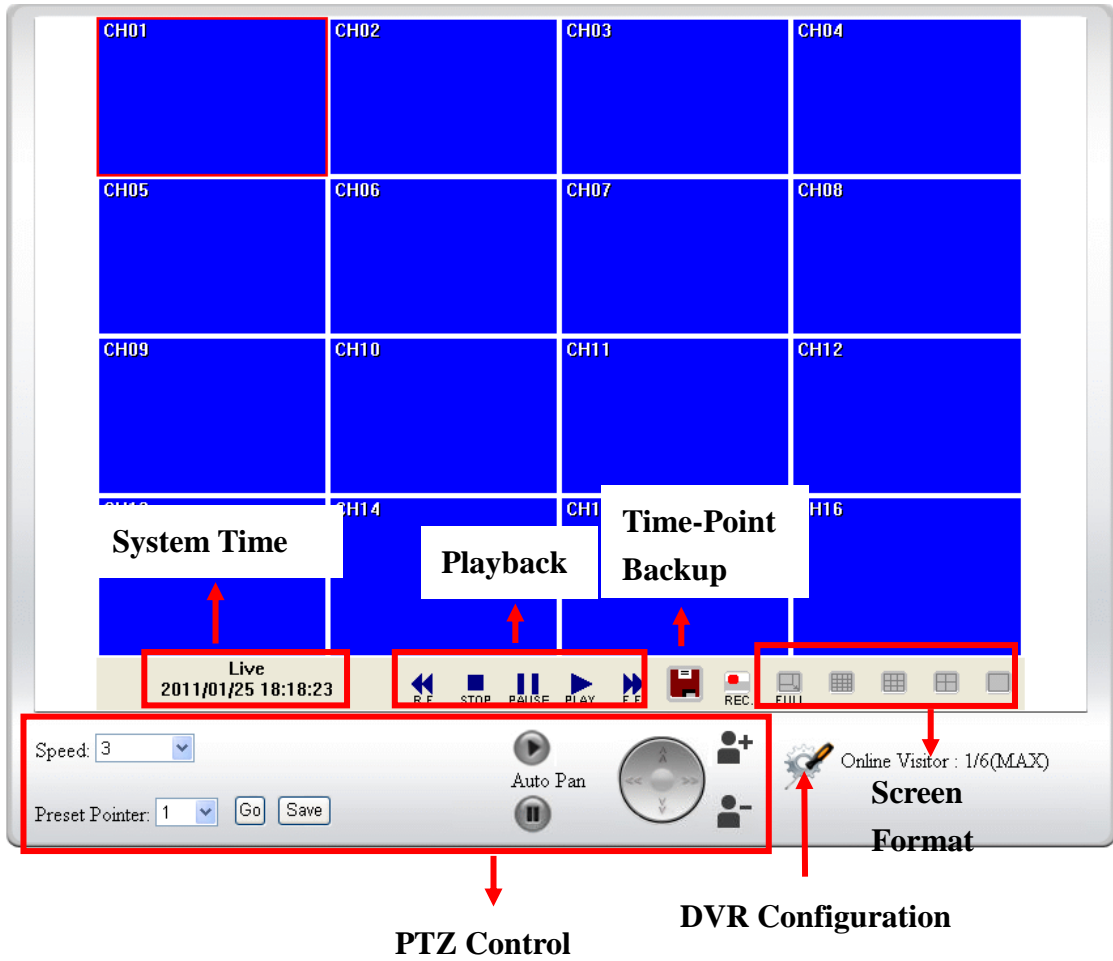

A. DVR Configuration

Get into DVR network menu.

B. PTZ Control

PTZ control function panel

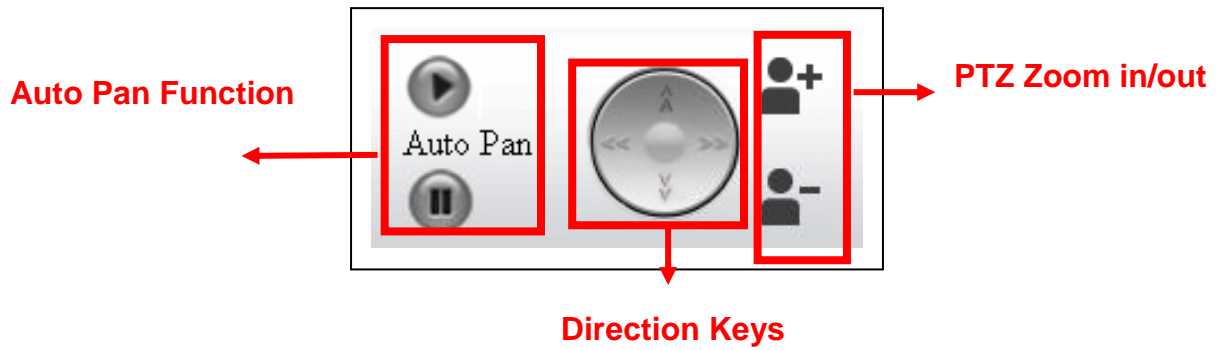

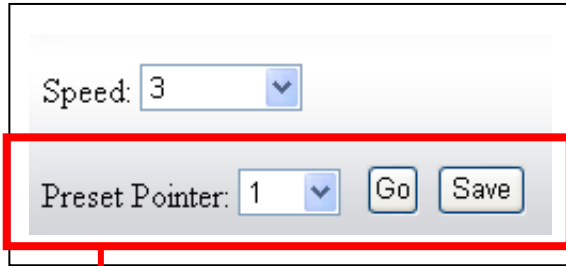

**Up to 32 preset points
for operation**

C. SYSTEM TIME

Live viewing mode: The current live viewing time.

D. SCREEN FORMAT

Switch screen format and click twice to switch different channels with full screen.

E.  **Full Screen.** Click again to return.

F.  **REC.** Videos are saved as AVI file.

G.  **Playback**

H.  **Time-Point Backup**

Click  and playback window will popup

PLAYBACK by TIME SEARCH & EVENT SEARCH

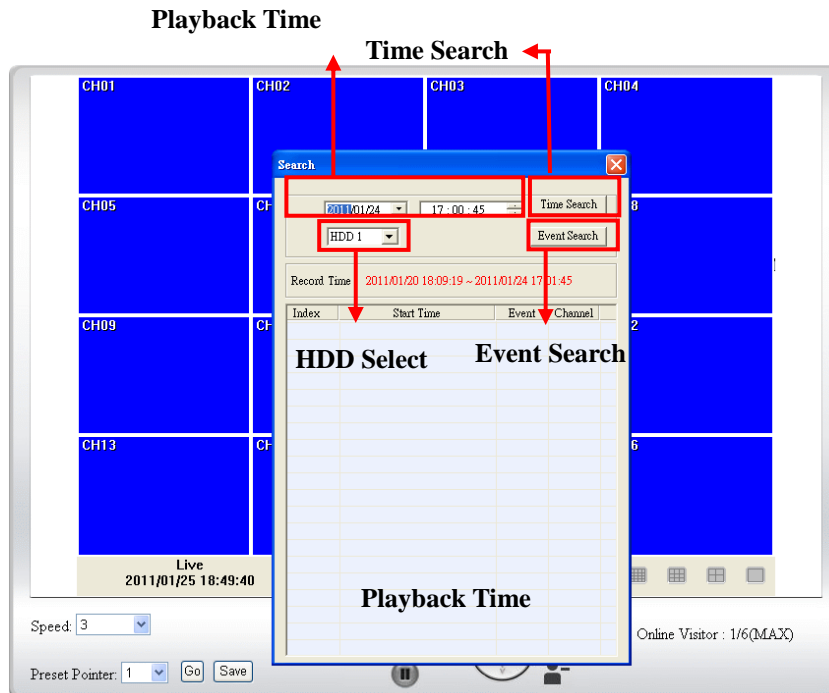

A. HDD Select

User can select HDD1 or HDD2 for playback

B. Playback Time

User can select the time then press "Time Search" for playback.

C. Time Search

User can select the time then press "Time Search" for playback.

D. Event Search

User can select event item by pressing "Event Search" for playback.

Click  to operate Time-Point backup.

TIME-POINT BACKUP

First, select Start and End backup time which have to among the Record Time.

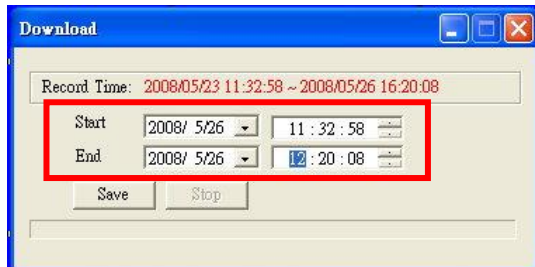

Then, click **Save** button to select the position on PC where the user is going to backup the data. After that, press **OK** button to start the backup.

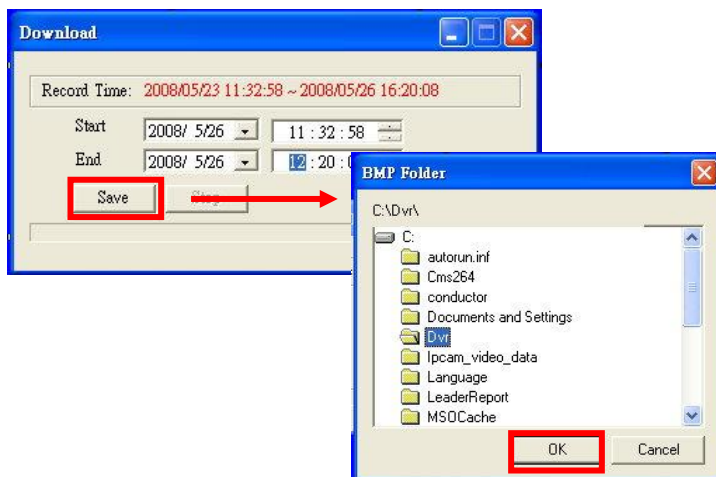

Finally, double-click the left button of the mouse to open the saved backup file. The backup file

will named as the time when start to backup, such as, (20080526113258.264) will be 2008/05/26 11:32:58.



OTHER FUNCTIONS

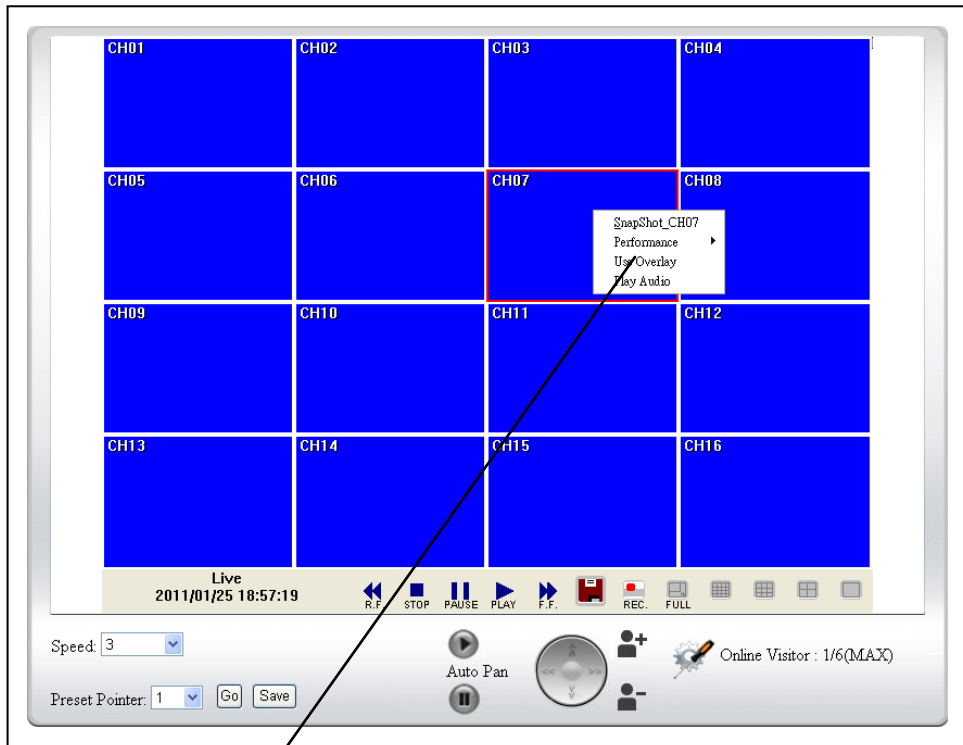

User can use other functions by clicking the left of mouse

A. Snapshot:

User can save any single picture from image.

B. Performance:

User can select image quality (high, medium & low).

C. Use Overlay:

User can use Overlay function.

D. Play audio:

User can play audio function by channel.

Note: remote user can receive audio from DVR & the audio will be saved with image when processing video backup.

6.5 CONFIGURE

A. System - System Information

System Information	
Server Information	
Server Name:	<input type="text" value="DVR-16"/>
MAC Address:	<input type="text" value="00:0f:0d:00:12:3a"/>
NTP Setting	
Time zone:	<input type="text" value="GMT-12:00"/>
NTP Server:	<input type="text" value="198.123.30.132"/>
<input type="button" value="Apply"/>	

A-1 SYSTEM INFORMATION

SERVER NAME: This name will show on the IP Installer.

A-2 NTP Setting

NTP SERVER: Revise the time of DVR via different NTP Server.

Note: Time zone and Interval cannot adjust in here (User can adjust both in DATE and TIME SETUP option of DVR Menu).

B. SYSTEM – USER MANAGEMENT

User Management				
Authority Setting				
HDD Format	<input type="radio"/>	Enable	<input checked="" type="radio"/>	Disable
Password Check	<input type="radio"/>	Enable	<input checked="" type="radio"/>	Disable
Anonymous Login	<input type="radio"/>	Enable	<input checked="" type="radio"/>	Disable
Password Protection	<input type="radio"/>	Enable	<input checked="" type="radio"/>	Disable
<input type="button" value="Apply"/>				
User List				
Username	Modify	Remove	<input type="button" value="Add User"/>	
admin	Edit			

User Management provides 3 levels of limits of authority: Administrator (the highest), User, and Guest.

Administrator: Possessing the highest level of authority to operate full functions within network.

User: Having Live Image and Video Playback authority. Moreover, PTZ controlled is included as well.

Guest: Only have Live Image authority.

Default administrator account: Username: admin Password: admin

B-1. ANONYMOUS USER LOGIN:

YES: Accept anonymous user login without password as guest login.

NO: Anonymous login unacceptable.

B-2. USER MANAGEMENT:

Add: Input Username and Password and then click on **Add/Set** to save.

Modify: Click on selected User name on User List and the following window will popup. After inputting Password and Confirm Password, click on **OK**.

Remove: Click on selected User name on the user list and click on **Remove**.



C. SYSTEM / SYSTEM UPDATE

C-1. Firmware Upgrade: Click on the “Browse” button to select the latest firmware and then press “Upgrade” button to upgrade the firmware.

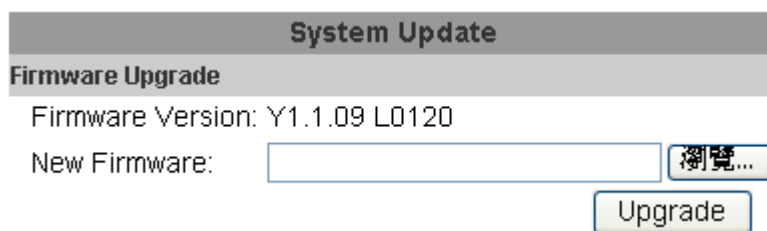

C-2. Load Default: There are three kinds of Settings. One is Load Setup From Default, another is Load Setup From and the other is Backup Setup.

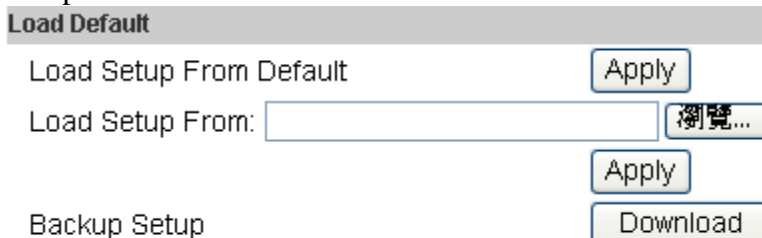

Load Setup From Default: Press “Setting” button to load factory default.

Load Setup From: Click on “Browse...” button to select DVR setting file and then press “Setting” button to upload the setting file to DVR.

Backup Setup: Click on “Download” button to download the DVR setting file into the specific storage device.

D. NETWORK – IP SETTING

IP Setting	
IP Assignment	
<input type="radio"/> DHCP	
<input checked="" type="radio"/> Static	
IP Address:	<input type="text" value="192.168.22.56"/>
Subnet Mask:	<input type="text" value="255.255.255.0"/>
Gateway:	<input type="text" value="192.168.22.254"/>
DNS 1:	<input type="text" value="168.95.1.1"/>
DNS 2:	<input type="text" value="168.192.95.1"/>
Port Assignment	
Web Page Port:	<input type="text" value="80"/>
<input type="button" value="Apply"/>	

D-1. IP ASSIGNMENT

DHCP: In Dynamic Host Configuration Protocol (DHCP) mode, DHCP server will get setting done automatically.

STATIC IP: Please input IP address, Subnet Mask, and Gateway based on network environment.

D-2. PORT ASSIGNMENT

With IP Share (Router), the following Ports needed to be adjusted in case of conflict.

E. NETWORK – PPPoE

PPPoE	
PPPoE Setting	
<input type="radio"/> Enabled	<input checked="" type="radio"/> Disabled
Username:	<input type="text"/>
Password:	<input type="text"/>
Send mail after dialed	
<input type="checkbox"/> Enabled	
Subject:	<input type="text" value="DVR is dialed"/>
<input type="button" value="Apply"/>	

E-1. PPPoE SETTING

Click on Enabled to enable ADSL dial function.

Username: Username for ADSL account.

Password: Password for ADSL account.

After dialed successfully, new IP address will appear.

E-2. SEND MAIL AFTER DIALED

Click on Enabled to enable SEND MAIL AFTER DIALED function.

E-3. SUBJECT

Mail subject.

F. NETWORK / DDNS SETTING

DDNS	
DDNS Setting	
<input type="radio"/> Enabled	<input checked="" type="radio"/> Disabled
Provider:	<input type="text" value="dyndns.org"/>
Hostname:	<input type="text"/>
Username:	<input type="text"/>
Password:	<input type="text"/>
Schedule Update:	<input type="text" value="1440"/> Minutes
State	
<input type="text" value="IDLE."/>	
<input type="button" value="Apply"/>	

Note:

1. Schedule Update: Feature of DDNS schedule update is designed for IP products which installed behind the ICS or NAT devices. Update range from every 5 (minutes) to 5000 (minutes) and 0 remain to off.
2. Please note that the hostname will be blocked by DynDNS.org if schedule update is more than once every 5 minutes to 60 minutes. In general, schedule update in every 1440 minutes is recommended.

Click on Enabled to enable DDNS function.

F-1. DYNDNS.ORG

DDNS

DDNS Setting

Enabled Disabled

Provider: **dyndns.org**

Hostname:

Username:

Password:

Schedule Update: **0** Minutes

State

Apply

DDNS SETTING - DYNDNS.ORG

PROVIDER: Select dyndns.org

HOSTNAME: The registered hostname in DYNDNS.ORG.

USERNAME: The registered username in DYNDNS.ORG.

PASSWORD: The registered password in DYNDNS.ORG.

SCHEDULE UPDATE: A period of time to update IP address.

STATE

1. Updating: Information update.
2. Idle: Stop service.
3. DDNS registered successfully, now log by
<http://<username>.ddns.camddns.com>: Registered successfully.
4. Updating Failed, the name is already registered.
5. Updating Failed, please check your internet connection.

F-2. DDNS.CAMNDS.COM

DDNS

DDNS Setting

Enabled Disabled

Provider: **ddns.camddns.com**

Username:

Schedule Update: **10** Minutes

State

IDEL.

Apply

Note:

1. Schedule Update: Feature of DDNS schedule update is designed for IP products which installed behind the ICS or NAT devices. Update range from every 5 (minutes) to 5000 (minutes) and 0 remain to off.
2. Please note that the hostname will be blocked by DynDNS.org if schedule update is more than once every 5 minutes to 60 minutes. In general, schedule update in every 1440 minutes is recommended.

DDNS SETTING – DDNS.CAMDdns.COM

PROVIDER: Select ddns.camddns.com

USERNAME: The registered username in DDNS.CAMDdns.COM.

SCHEDULE UPDATE: A period of time to update IP address.

STATE

1. Updating: Information update.
2. Idle: Stop service.
3. DDNS registered successfully, now log by
http://<username>.ddns.camddns.com: Registered successfully.
4. Updating Failed, the name is already registered.
5. Updating Failed, please check your internet connection.

DDNS Setting Steps:

Press ① “ENABLE” option to enable DDNS function and select ②

“**ddns.camddns.com**” of the provider drop down list which is suggested to use. In

the following, insert ③ the username which the user wants to apply

(i.e. **DVR_GODDNS** in here). After that, click ④ “Apply” button to apply a

DDNS domain name.

The screenshot shows the DDNS configuration interface. At the top is a header 'DDNS'. Below it is a section 'DDNS Setting' containing several fields: 'Enabled' (radio button selected, circled in red with '1.'), 'Disabled' (radio button unselected), 'Provider:' (dropdown menu showing 'ddns.camddns.com', circled in red with '2.'), 'Username:' (text box containing 'DVR_GODDNS', circled in red with '3.'), and 'Schedule Update:' (text box containing '60' and 'Minutes'). Below this is a 'State' section with a dropdown menu showing 'Updating...'. At the bottom right is an 'Apply' button, circled in red with '4.'

Finally, the DVR domain name **5** (http://DVR_GODDNS.ddns.camddns.com) will be shown on the state block.

DDNS

DDNS Setting

Enabled Disabled

Provider:

Username:

Schedule Update: Minutes

State

5.

Apply

- NOTE:**
1. If the user selects another provider which is ddns2.ydsdvr.com, all of the setting steps are the same with ddns.camddns.com setting.
 2. However, if dyndns.org provider is selected, please go to www.dyndns.org website to register the account first. The user has to fill in the username, password and hostname for applying the account. After the user applied the account successfully, the dyndns.org will give the user a complete DDNS domain name.
 3. If setting up IP schedule update too frequently, the IP may be blocked. In general, schedule update every day (1440 minutes) is recommended.

G. NETWORK / Mail & FTP

Click on “Motion” or “Alarm” option to enable Mail Setting and FTP Setting function.

Mail & FTP

Mail Setting: Motion Alarm

Mail Server:

SMTP Port:

Username:

Password:

Sender's Mail:

Receiver's Mail:

Bcc Mail:

Event Subject:

FTP Setting: Motion Alarm

FTP Server:

Username:

Password:

Port:

Path:

Apply

Mail Server: The IP address of Mail Server.

SMTP Port: The port of SMTP (known as Simple Mail Transfer Protocol). (Default value is 25)

Username: The username while log in to the mail server.

Password: The password while log in to the mail server.

Sender's Mail: The sender's account when send the mail via this mail server.

Receiver's Mail: The receiver's mail address.

Bcc Mail: The receiver's mail address for Bcc Mail.

Event Subject: The subject of this mail. (Default value is ALARM MAIL)

FTP Server: The IP address of FTP Server.

Username: The username while log in to the ftp server.

Password: The password while log in to the ftp server.

Port: The port number of file transmission. (Default value is 21)

Path: The ftp path where the user wants to reserve the information.

Finally, click on **Apply** button to reserve the setting.

H. OTHERS/ Mobile Viewer

Click the drop down list of connection mode to select the sort of mobile viewer connection. Then click **Apply** to reserve the setting. There is only JAVA / iPhone option. Moreover, the video quality can be setup as well.

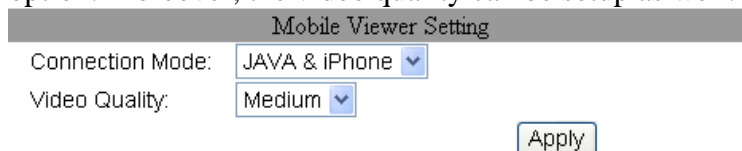

I. OTHERS / Player Downloaded

User can click "Run" button to download the player to local PC.

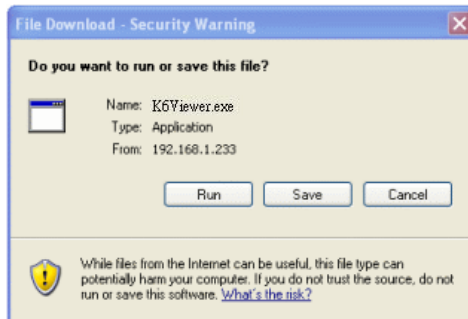

J. OTHERS / DVR Setting

DVR setting can be changed via the Internet.

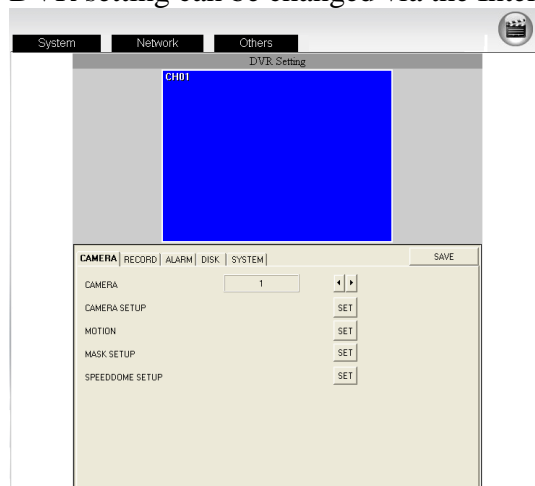

APPENDIX A: RECORDING TIME LAPSE (HOURS)

FULL D1-720 x 480

500 GB HDD						UNIT: HOURS
RECORDING SPEED (IPS)	LOW	MEDIUM	STANDARD	HIGH	BEST	
	AVERAGE	AVERAGE	AVERAGE	AVERAGE	AVERAGE	
	5	7.1	10.3	12.1	15.7	
	240	121	85	58	50	38
120	242	170	117	100	77	
60	485	341	235	200	154	
30	970	683	471	401	309	
15	1941	1367	942	802	618	

1T HDD						UNIT: HOURS
RECORDING SPEED (IPS)	LOW	MEDIUM	STANDARD	HIGH	BEST	
	AVERAGE	AVERAGE	AVERAGE	AVERAGE	AVERAGE	
	5	7.1	10.3	12.1	15.7	
	240	242	170	117	100	77
120	485	341	235	200	154	
60	970	683	471	401	309	
30	1941	1367	942	802	618	
15	3883	2734	1885	1604	1236	

1.5T HDD						UNIT: HOURS
RECORDING SPEED (IPS)	LOW	MEDIUM	STANDARD	HIGH	BEST	
	AVERAGE	AVERAGE	AVERAGE	AVERAGE	AVERAGE	
	5	7.1	10.3	12.1	15.7	
	240	364	256	176	150	115
120	728	512	353	300	231	
60	1456	1025	706	601	463	
30	2912	2051	1413	1203	927	
15	5825	4104	2827	2407	1855	

2THDD						UNIT: HOURS
RECORDING SPEED (IPS)	LOW	MEDIUM	STANDARD	HIGH	BEST	
	AVERAGE	AVERAGE	AVERAGE	AVERAGE	AVERAGE	
	5	7.1	10.3	12.1	15.7	
	240	485	341	235	200	154

120	970	683	471	401	309
60	1941	1367	942	802	618
30	3883	2734	1885	1604	1236
15	7767	5469	3770	3209	2473

Half D1- 720x240

500 GB HDD						UNIT: HOURS
RECORDING SPEED (IPS)						
	LOW	MEDIUM	STANDARD	HIGH	BEST	
	AVERAGE	AVERAGE	AVERAGE	AVERAGE	AVERAGE	
	3	5	7.2	10.1	12.8	
240	202	121	84	60	47	
120	404	242	168	120	94	
60	809	485	337	240	189	
30	1618	970	674	480	379	
15	3236	1941	1348	961	758	
1T HDD						UNIT: HOURS
RECORDING SPEED (IPS)						
	LOW	MEDIUM	STANDARD	HIGH	BEST	
	AVERAGE	AVERAGE	AVERAGE	AVERAGE	AVERAGE	
	3	5	7.2	10.1	12.8	
240	404	242	168	120	94	
120	809	485	337	240	189	
60	1618	970	674	480	379	
30	3236	1941	1348	961	758	
15	6472	3883	2696	1922	1517	
1.5T HDD						UNIT: HOURS
RECORDING SPEED (IPS)						
	LOW	MEDIUM	STANDARD	HIGH	BEST	
	AVERAGE	AVERAGE	AVERAGE	AVERAGE	AVERAGE	
	3	5	7.2	10.1	12.8	
240	606	364	252	180	142	
120	1213	728	505	360	284	
60	2427	1456	1011	720	568	
30	4854	2912	2022	1441	1137	
15	9709	5825	4045	2883	2275	
2THDD						UNIT: HOURS
RECORDING SPEED (IPS)						
	LOW	MEDIUM	STANDARD	HIGH	BEST	
	AVERAGE	AVERAGE	AVERAGE	AVERAGE	AVERAGE	
	3	5	7.2	10.1	12.8	
240	809	485	337	240	189	
120	1618	970	674	480	379	

60	3236	1941	1348	961	758
30	6472	3883	2696	1922	1517
15	12945	7767	5393	3845	3034

CIF-360x240

500 GB HDD						UNIT: HOURS
RECORDING SPEED (IPS)						
	LOW	MEDIUM	STANDARD	HIGH	BEST	
	AVERAGE	AVERAGE	AVERAGE	AVERAGE	AVERAGE	
	1.6	2.6	4.8	8	9.9	
240	379	233	126	76	61	
120	759	467	253	152	123	
60	1517	934	505	303	245	
30	3034	1867	1011	607	500	
15	6068	3734	2023	1214	981	

1T HDD						UNIT: HOURS
RECORDING SPEED (IPS)						
	LOW	MEDIUM	STANDARD	HIGH	BEST	
	AVERAGE	AVERAGE	AVERAGE	AVERAGE	AVERAGE	
	1.6	2.6	4.8	8	9.9	
240	759	467	253	152	123	
120	1517	934	506	303	245	
60	3034	1867	1011	607	490	
30	6068	3734	2023	1214	981	
15	12136	7468	4045	2427	1961	

1.5T HDD						UNIT: HOURS
RECORDING SPEED (IPS)						
	LOW	MEDIUM	STANDARD	HIGH	BEST	
	AVERAGE	AVERAGE	AVERAGE	AVERAGE	AVERAGE	
	1.6	2.6	4.8	8	9.9	
240	1138	700	379	228	184	
120	2276	1400	759	455	368	
60	4551	2801	1517	910	736	
30	9102	5601	3034	1820	1471	
15	18204	11203	6068	3641	2942	

2THDD						UNIT: HOURS
RECORDING SPEED (IPS)						
	LOW	MEDIUM	STANDARD	HIGH	BEST	
	AVERAGE	AVERAGE	AVERAGE	AVERAGE	AVERAGE	
	1.6	2.6	4.8	8	9.9	
240	1517	934	506	303	245	
120	3034	1867	1011	607	490	

60	6068	3734	2023	1214	981
30	12136	7468	4045	2427	1961
15	24273	14937	8091	4855	3923

* The value is for reference only

APPENDIX B: HDD COMPATIBLE TABLE

Brand	Model	Capacity	others
SEAGATE	STM3250820AS	250 GB	7200 10
	ST3250310SV	250GB	SV35.3
	ST3400620AS	400 GB	7200 10
	ST3500320SV	500GB	SV35.3
	ST3500320AS	500GB	7200 11
	ST3500418AS	500GB	7200 12
	ST3750640AS	750 GB	7200 10
	ST3750330AS	750 GB	7200 11
	ST31000333AS	1TB	7200 11
	ST31000340AS	1TB	7200 11
	ST31000340NS	1TB	Barracuda ES.2
	ST31000340SV	1TB	SV35.3
	ST31500341AS	1.5TB	7200 11
WD	WD1600AAJS	160 GB	7200 CB
	WD2500AAKS	250 GB	7200 CB
	WD2500AVVS	250 GB	7200 GP
	WD5000AACS	500 GB	7200 GP
	WD5000AVVS	500 GB	7200 GP
	WD5000AAKS	500GB	7200 CB
	WD6400AAKS	640 GB	7200 BLUE
	WD6400AVVS	640 GB	7200 GP
	WD7500AACS	750GB	7200 GP
	WD7500AVVS	750GB	7200 GP
	WD10EACS	1TB	7200 GP
	WD10EADS	1TB	Caviar Green
	WD10EVDS	1TB	Green Power
	WD10EVVS	1TB	7200 GP
	WD15EADS	1.5TB	7200 GP
	WD15EARS	1.5TB	7200 GP
	WD20EADS	2.0TB	7200 GP
HITACHI	HDS721616PLA380	160 GB	7200
	HDT725025VLA380	250 GB	7200
	HDT725032VLA360	320 GB	7200
	HDP725050GLA360	500 GB	7200
	HCP725050GLA380	500GB	7200
	HDT721010SLA360	1TB	7200

* The compatible table is for reference only

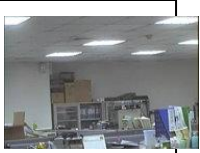

PENDIX C: ERROR MESSAGE LIST

ERROR MESSAGE	ERROR STATUS & REASON	NOTE
DISK ACCESS ERROR!	H.D.D. Data structure Un-normal. Data does not record into DVR or bad sector on DVR H.D.D. Please install another H.D.D. and perform the record again.	
UPDATE FILE ERROR!	Please re-download the update file and update again.	
FIRMWARE UPGRADE FAILED	Please reboot the DVR and upgrade the firmware. Please send the DVR back to repair when DVR is disability.	
MEDIA ACCESS FAIL!	The USB file format is incorrect (Please format the pen drive to FAT32) or Pen Drive is setup to ONLY READ mode (Please annul ONLY READ mode) when reserve the data by using Pen Drive. The data cannot be burn into CD/DVD disc. Please change another CD/DVD disc and backup the file in CD/DVD disc storage.	
NO FILE!	There is no upgrade file within Pen Drive or the name of upgrade file does not correspond with DVR format. Please adjust the upgrade file name based on the following information. 16CH -> UpdateR.bin 08CH -> Update8.bin 04CH -> Update4.bin	
USB DEVICE NOT FOUND NO USB	Pen Drive undetected. Please Unplug the Pen Drive and plug it again.	
BACKUP START TIME ERROR	Backup start time error.	
BACKUPEND TIME ERROR	Backup end time error.	
DISK ERROR	The data cannot be burn into CD/DVD disc. Please change another CD/DVD disc and backup the file.	
FAN FAILED	Fan Error Warning.	
NO LOG DATA	No Events Record.	
SCHEDULE RECORD	The condition is caused by trying to stop recording when perform the schedule record. Please setup the record to manual mode and then stop the record.	
PLEASE SELECT ONE CAMERA	The message will be shown while using the ZOOM function under split screen condition. Please switch the screen into full screen mode and then operate the ZOOM function.	