

1CH Video Server

Quick Installation Guide

1

Getting Started

1.1 PACKAGE CONTENTS

Video Server

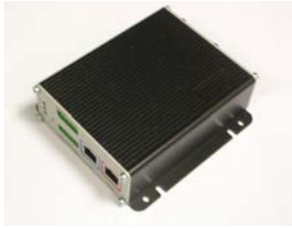

Software CD



Power Adaptor



Terminal Blocks & Screws



1.2 PHYSICAL DESCRIPTION

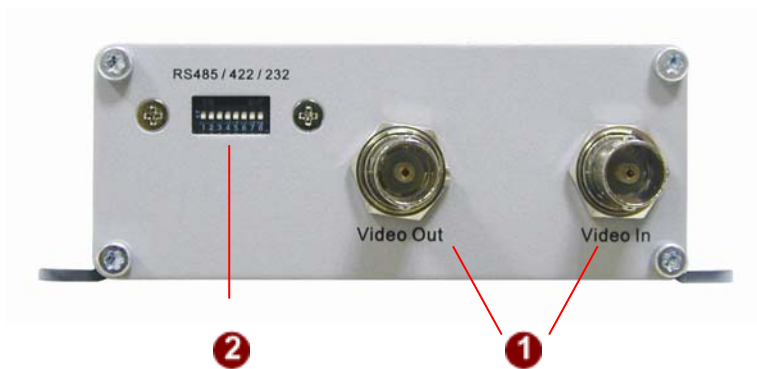

1. Video Input / Output

The video server supports one analog video input and output of composite signal with BNC connectors

2. Dip Switch for Serial Port

RS-485 or RS-422 pin define (default is RS-485)



RS-232 pin define

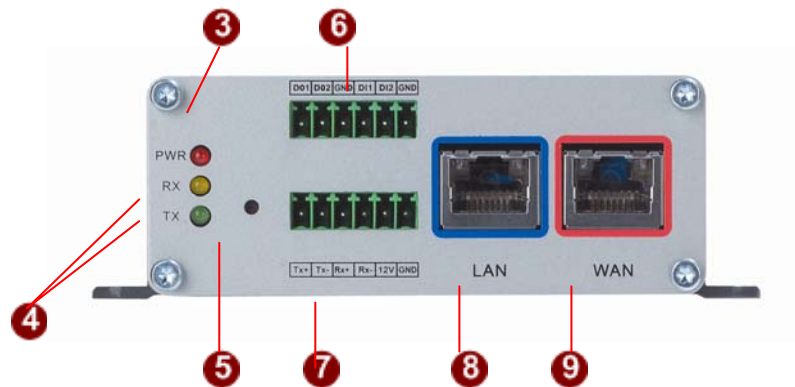

3. Action LED Indicator

The LED will light up after video server has successfully completed the boot process.

4. Serial Port LED Indicator

LEDs indicating when serial port is active.

5. Reset Button

Step 1: Switch off video server by disconnecting the power cable

Step 2: Using a suitable pointed object, press and continue to hold the Reset Button depressed. While continuing to hold the reset button depressed, reconnect the power cable.

Step 3: Keep holding the reset button depressed around 6 seconds, release the reset button. The unit will start up with factory default settings.

6. Terminal Blocks Pin 1~6

The video server supports two alarm input and two alarm output.

DI: Logic Level 0: 0~0.4V; Logic Level 1: 3.3~30V

DO: Logic Level 0: 0.1~0.6V; Logic Level1: 2.4~5V



PIN	NAME	DESCRIPTION
1	DO1	Digital Output 1
2	DO2	Digital Output 2
3	GND	Ground Pin
4	DI1	Digital Input 1
5	DI2	Digital Input 2
6	GND	Ground Pin

7. Terminal Blocks Pin 7~12

Pin 7~10: RS232/422/485. Default mode is RS-485

Pin 11~12: DC 12V power input

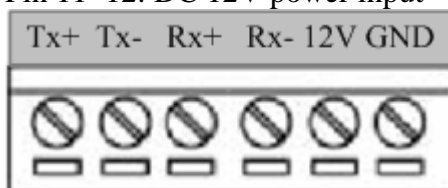

PIN	NAME	DESCRIPTION		
		RS-485	RS-422	RS-232
7	Tx+	D+	Tx+	Tx
8	Tx-	D-	Tx-	
9	Rx+		Rx+	Rx
10	Rx-		Rx-	

11	12V	Power Input (DC +12V)
12	GND	Ground Pin of Power Input & RS-232

8. LAN Port

The Video server connects to the LAN (local area network) via a standard RJ45 connector. Supporting NWAY, this Video server can auto detect the speed of local network segment (10Base-T/100Base-TX Ethernet).

9. WAN Port

The Video server connects to the WAN (wide area network) via a standard RJ45 connector. Supporting NWAY, this Video server can auto detect the speed of local network segment (10Base-T/100Base-TX Ethernet). The WAN port is for FTTH and can connect to a xDSL or cable modem.

1.3 CONNECT NECESSARY CABLES

The BNC cable for video input, Ethernet cable and power cable are necessary for previewing function. Make sure all cables are correctly and firmly connected.

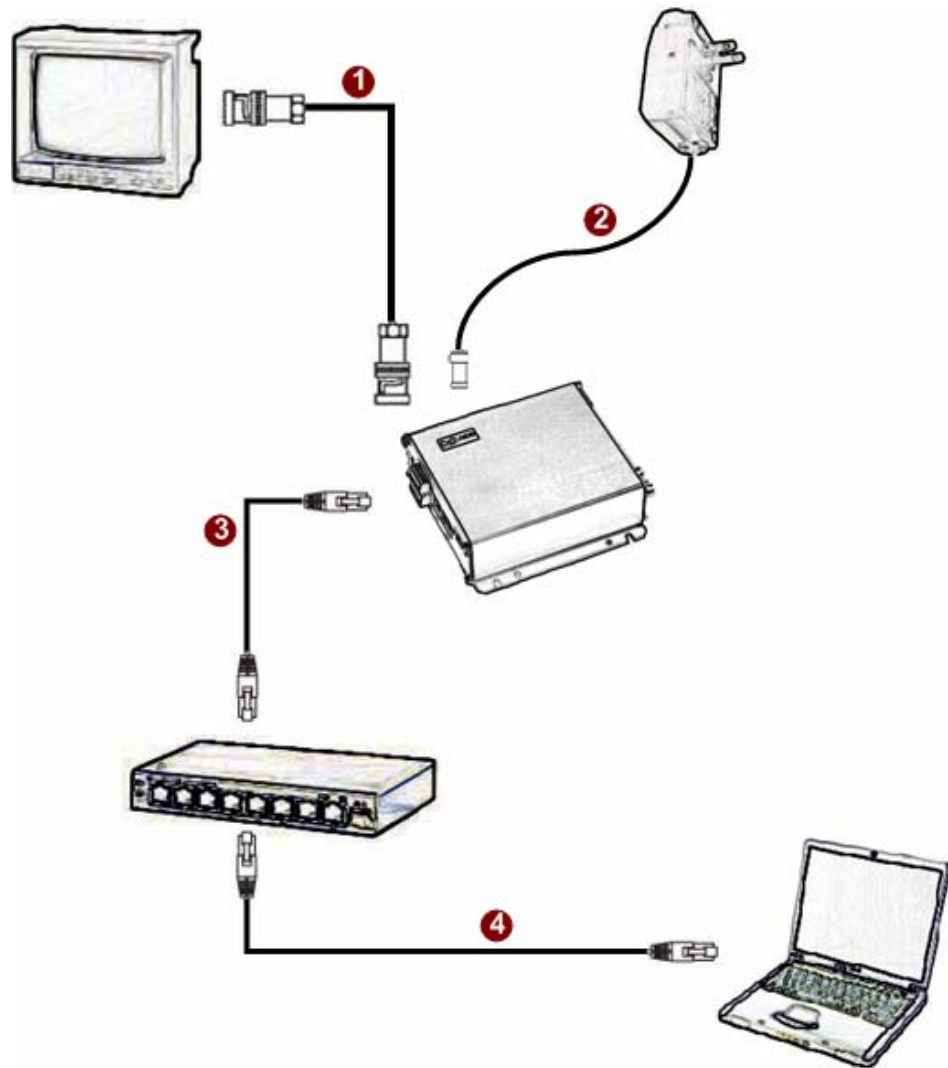

1. Connect an analog monitor to video server video out (BNC connector).
2. Connect the power adaptor to video server
3. Connect the video server's LAN port to an Ethernet (RJ45 connectors)
4. Connect a PC to the Ethernet hub (RJ45 connectors)

2

Quick Tour

This section guides you with a quick tour on Video Server.

2.1 Configure Video Server

2.1.1 Make sure network environment

Default IP of Video Server is 192.168.0.100. Please make sure Video Server and your PC are on the same network segment before running the installation.

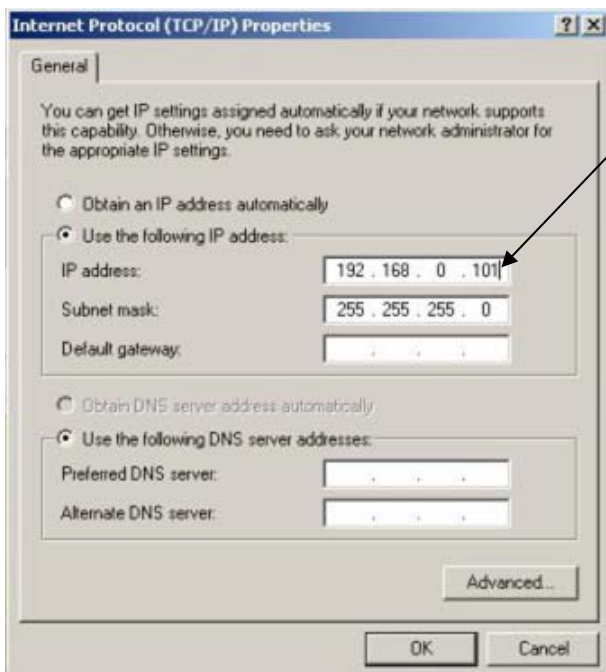

Please set the settings as below.

IP address: 192.168.0.xxx
Subnet mask: 255.255.255.0

(NOTE: xxx should be a number from 1 to 254, but 100 is excepted.)

2.1.2 Open Internet Explorer with IP Address

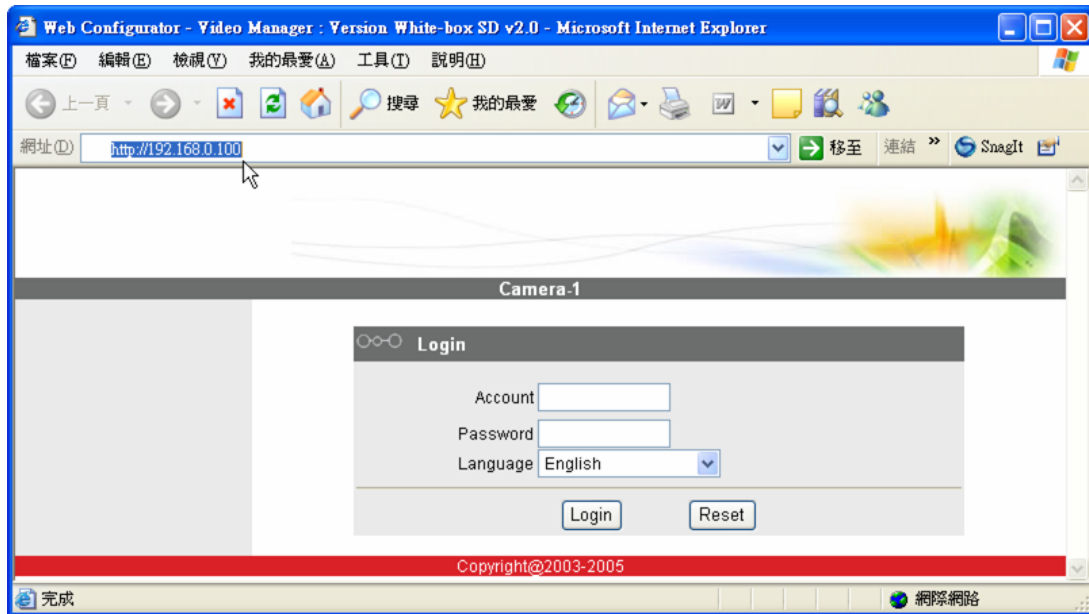

NOTE: If your web browser is earlier than IE6, then download IE6 is recommended.



NOTE: Video Server default IP address is set to **192.168.0.100**

2.1.3 Login with default administrator's account & password



NOTE: Default administrator account is set to **Admin**, password is set to **123456**, and click  button.

2.1.4 Preview the video



NOTE: In your Client PC, please make sure the setting of Network Connections Type is set to Auto Negotiation, since Video Server follows MII standard. Otherwise, you might not see the live video.

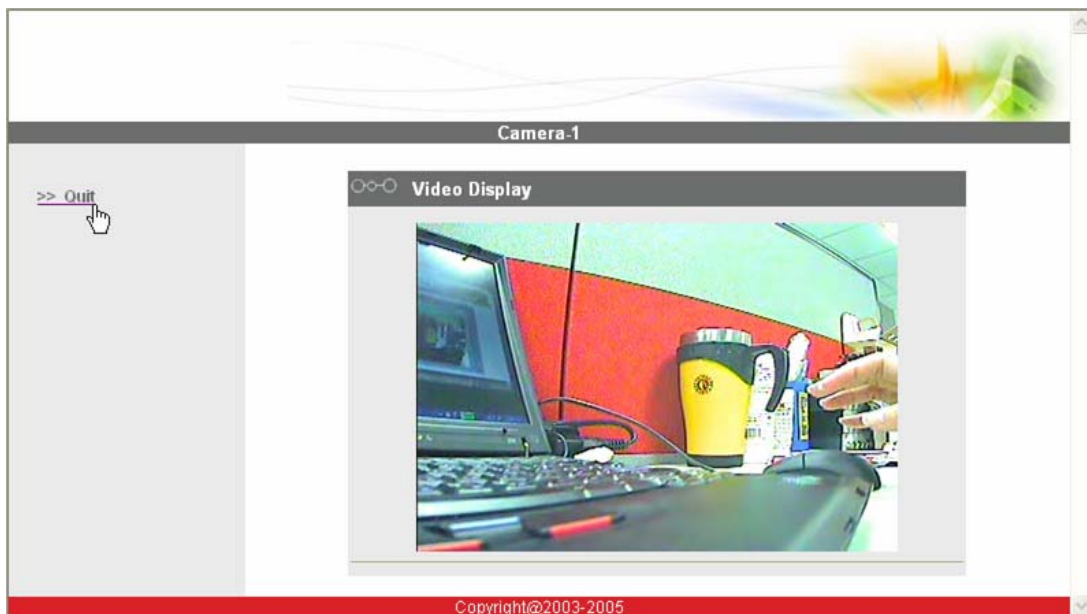

2.15 Set the new IP address

The screenshot shows the 'Camera-1' web configurator interface. On the left is a navigation menu with options: Video Display, Host Setting, WAN Setting, Date Setting, Video Setting, Video Adjust, User Account, System Info, Firmware, Factory Default, Save Reboot, and Logout. The main content area is divided into three sections:

- Host Setting:** Host Name (text input, callout 1), Language (dropdown menu set to 'English', callout 2), Apply (callout 3), and Reset (callout 4) buttons.
- LAN Setting:** IP Address (four text inputs: 192, 168, 0, 100, callout 5), Subnet Mask (four text inputs: 255, 255, 255, 0, callout 6), Apply (callout 3), and Reset (callout 4) buttons.
- Network Link Speed & Duplex:** LAN Port (dropdown menu set to 'Auto Detect', callout 7), WAN Port (dropdown menu set to 'Auto Detect', callout 8), Apply (callout 3), and Reset (callout 4) buttons.

Copyright@2003-2005

***Host Name** : Enter the domain name for Video Server

***Language** : Language setting for Web Configurator after Save Reboot. Default setting is English.

***IP Address** : The IP address of the LAN interface. The default IP address is 192.168.0.100.

***Subnet Mask** : The subnet mask of the LAN interface. The default subnet mask is 255.255.255.0

*Click  button



NOTE: Check with your MIS department, if Client PC and Video Server are setting in different VLANs, please connect to WAN port.



NOTE: In your Client PC, please make sure the setting of Network Connections Type is set to Auto Negotiation, since Video Server follows MII standard. Otherwise, you might not see the live video.



IMPORTANT: After the IP address is changed, please record this IP address. There is no way to connect to the Video Server if user forgets the new IP address.

2.1.6 Check Default Video Setting

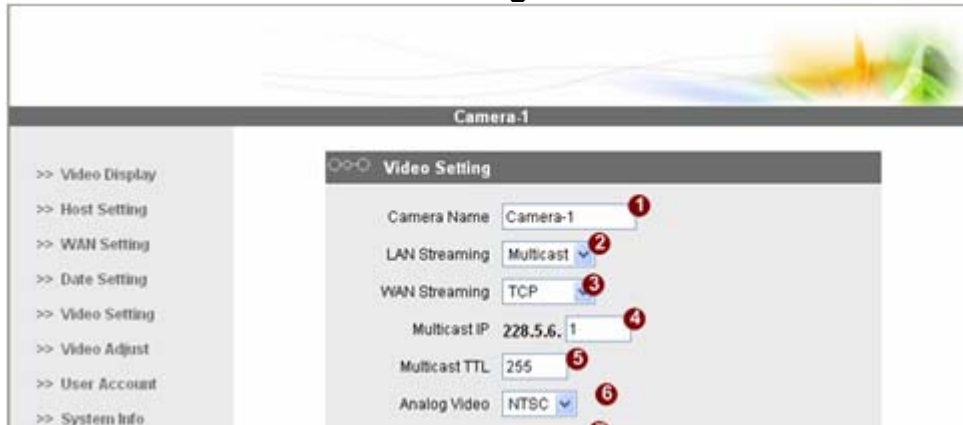

NOTE: Please make sure the TV Input (NTSC / PAL) is meet your requirement, and click **Apply** button.

2.1.7 Click **Save Reboot** to restore all settings and please wait about 30 seconds for system reboot.